

CTK-571 CTK-573

USER'S GUIDE
GUÍA DEL USUARIO



P
英西
CTK571/573-ES-1

CASIO®

GUIDELINES LAID DOWN BY FCC RULES FOR USE OF THE UNIT IN THE U.S.A. (not applicable to other areas).

NOTICE

This equipment has been tested and found to comply with the limits for a Class B digital device, pursuant to Part 15 of the FCC Rules. These limits are designed to provide reasonable protection against harmful interference in a residential installation. This equipment generates, uses and can radiate radio frequency energy and, if not installed and used in accordance with the instructions, may cause harmful interference to radio communications. However, there is no guarantee that interference will not occur in a particular installation. If this equipment does cause harmful interference to radio or television reception, which can be determined by turning the equipment off and on, the user is encouraged to try to correct the interference by one or more of the following measures:

- Reorient or relocate the receiving antenna.
- Increase the separation between the equipment and receiver.
- Connect the equipment into an outlet on a circuit different from that to which the receiver is connected.
- Consult the dealer or an experienced radio/TV technician for help.

FCC WARNING

Changes or modifications not expressly approved by the party responsible for compliance could void the user's authority to operate the equipment.

Welcome...

To the happy family of satisfied CASIO electronic musical instrument owners! To get the most out of the many features and functions of the keyboard, be sure to carefully read this manual and keep it on hand for future reference.

Important!

When using batteries, be sure to replace them or shift to one of the alternate power sources whenever you notice any of the following symptoms.

- Dim power supply indicator
- Instrument does not turn on.
- Dim, difficult to read display
- Abnormally low speaker/headphone volume
- Distortion of sound output
- Occasional interruption of sound when playing at high volumes
- Sudden power failure when playing at high volumes
- Dimming of the display when playing at high volume
- Continued sound output even after you release a key
- A totally different tone may sound
- Abnormal rhythm pattern and demo tune play
- Loss of power, sound distortion, or low volume when playing from a connected computer or MIDI device

Use of any other corporate or product name should not be regarded as affecting the validity of any trademark or service mark. All other product and company names mentioned herein may be the trademarks of their respective owners.



CASIO ELECTRONICS CO., LTD.
Unit 6, 1000
North Circular Road
London NW2 7JD, U.K.

This mark is valid in the EU countries only.
Please keep all information for future reference.



Main Features

137 tones

- Everything from orchestra instruments to synthesized sounds, drum sets and more.

100 rhythms

- A selection of rhythms that cover rock, pops, jazz and just about any other musical style imaginable.

Auto Accompaniment

- Simply play a chord and the corresponding rhythm, bass, and chords parts play along automatically. One Touch Presets instantly recalls the most suitable tone and tempo settings to match the rhythm you are using.

100 built-in tunes, including piano tunes

- Built-in tunes come in three groups: Song Bank (50 Auto Accompaniment tunes), Etude (20 piano tunes), and Concert Piece (30 piano tunes). In each group, you can playback tunes for your own listening enjoyment, or cut out the melody or another part of a tune and play along with it.

3-step lesson

- 3-step lesson provides you with on-screen guidance of fingerings for playing along with Song Bank, Etude, or Concert Piece tunes. First practice the timing of the notes. Next, play along at your own pace. Soon you will be ready for step three, where you play along at normal speed.

Musical Information System

- A big LCD screen graphically shows you fingerings, keyboard keys to be pressed, and notes, making keyboard play more informative and enjoyable than ever before. A built-in backlight keeps the display easy to read, even in total darkness.

Memory function

- Record up to two parts in memory for later playback. Realistic ensemble play can also be created using the Auto Accompaniment function.
- The on-screen keyboard guide shows fingerings for the melody as recorded songs are played back.

General MIDI compatibility

- General MIDI tones let you connect to a personal computer and enjoy “desktop music” capabilities. This keyboard can be used as a desktop music input device or as a sound source, and it’s just the thing for play back of commercially available pre-recorded General MIDI music software.

Display Indications for Received MIDI Messages

- When playing General MIDI data, you can have information (keyboard and pedal data) about a specific channel appear on the display. You can also turn off a specific channel and play its part on the keyboard. You can even turn off the output of a channel and play along on the keyboard.

Safety Precautions

Symbols

Various symbols are used in this operating manual and on the product itself to ensure that the product is used safely and correctly, and to prevent injury to the user and other persons as well as damage to property. Those symbols along with their meanings are shown below.

WARNING

This indication stipulates matters that have the risk of causing death or serious injury if the product is operated incorrectly while ignoring this indication.

CAUTION

This indication stipulates matters that have the risk of causing injury as well as matters for which there is the likelihood of occurrence of physical damage only if the product is operated incorrectly while ignoring this indication.

Symbol Examples



This triangle symbol () means that the user should be careful. (The example at left indicates electrical shock caution.)



This circle with a line through it () means that the indicated action must not be performed. Indications within or nearby this symbol are specifically prohibited. (The example at left indicates that disassembly is prohibited.)



The black dot () means that the indicated action must be performed. Indications within this symbol are actions that are specifically instructed to be performed. (The example at left indicates that the power plug must be unplugged from the electrical socket.)

WARNING

Please use caution regarding the handling of the AC adaptor.

- Do not use a voltage other than the indicated power supply voltage. Use of a voltage other than that indicated may cause fire or electrical shock.
- If the power cord should become damaged (exposed wires, disconnection, etc.), purchase a new AC adaptor. Use of a damaged power cord may cause fire or electrical shock.
- Do not cut or damage the power cord. Also do not place heavy objects on top of it or subject it to excessive heat. Damage to the power cord may cause fire or electrical shock.
- Do not attempt to shape the power cord or subject it to excessive bending, twisting or pulling. This may cause fire or electrical shock.
- Please use the adaptor specified for this instrument. Use of another adaptor may cause fire, electrical shock, or malfunction.



Do not locate the instrument or its stand on an uneven or unstable surface.

- Locating the instrument or its stand on an uneven or unstable surface can cause it to fall, creating the danger of personal injury.

Do not place containers containing water or other liquids on the instrument.

- Do not place the following objects on the instrument. Placing such objects on the instrument may cause fire or electrical shock if they spill and get inside the instrument.
 - Containers filled with water or other liquids (including vases, potted plants, cups, cosmetics and medicines)
 - Small metal objects (including hairpins, sewing needles and coins)
 - Flammable objects



In the event a foreign object should happen to get inside the instrument, please take the following actions:

1. Turn power off.
2. Unplug the AC adaptor from the wall outlet.
3. If there are any batteries loaded in the keyboard, remove them.
 - Do not touch the batteries directly with your hands when removing them. They may be hot or battery fluid may be leaking from them.
4. Consult with the dealer where you purchased the keyboard or with an authorized CASIO service provider.



Do not disassemble or modify the instrument.

- Never attempt to take apart or modify the instrument, its accessories, or separately sold options. Doing so may cause fire, electrical shock or malfunction. Consult your dealer concerning all inspection, adjustment or repair of internal components.



Do not use if there is an abnormality or malfunction.

- Do not use the instrument if there appear to be abnormalities such as the presence of smoke or abnormal odor. Also do not use the instrument if there appear to be malfunctions such as the power not coming on or sound not being produced. Use under such conditions may cause fire or electrical shock. In such cases, take the following actions immediately. Never attempt to repair the instrument yourself.
 1. Turn power off.
 2. Unplug the AC adaptor from the wall outlet.
 3. If there are any batteries loaded in the keyboard, remove them.
 - Do not touch the batteries directly with your hands when removing them. They may be hot or battery fluid may be leaking from them.
 4. Consult with the dealer where you purchased the keyboard or with an authorized CASIO service provider.



When the instrument has been dropped:

- In the case the instrument has been dropped or damaged, take the following actions. Continued use may cause fire or electrical shock.
 1. Turn power off.
 2. Unplug the AC adaptor from the wall outlet.
 3. If there are any batteries loaded in the keyboard, remove them.
 - Do not touch the batteries directly with your hands when removing them. They may be hot or battery fluid may be leaking from them.
 4. Consult with the dealer where you purchased the keyboard or with an authorized CASIO service provider.



Be careful of the bags around children.

- Never allow anyone to place the plastic bags of the instrument, its accessories, and its separately sold options over their heads. Doing so may cause suffocation. Particular caution is required in homes with small children.

CAUTION

AC Adaptor

- Do not locate the power cord in close proximity to heaters or other heating appliances. This may cause the cord to melt leading to possible fire or electrical shock.
- When unplugging the AC adaptor from an electrical outlet, always make sure to pull on the adaptor itself and not the cord. Pulling excessively on the cord may cause it to be damaged or break leading to possible fire or electrical shock.
- Do not touch the AC adaptor with wet hands when it is plugged in. This may cause electrical shock.
- Be sure to unplug the AC adaptor from the electrical outlet during lightning storms and when you do not plan to use the keyboard for an extended period, such as when you go on a trip.
- After use turn off the power switch of the instrument and unplug the AC adaptor from the electrical outlet.
- At least once a year, unplug the AC adaptor from the power outlet and clean the area around the prongs of the plug. Dust build up around the prongs can create the danger of fire.



Batteries

- Improper battery use may cause batteries to rupture and leak. This may cause injury, malfunction of the instrument or discoloration of furniture and other articles that come into contact with battery fluid. Take care to observe the following.
 - Install batteries so their polarity (+/-) matches that indicated on the instrument.
 - For safety and to prevent possible leakage of battery fluid, always make sure to remove batteries from the instrument when you do not plan to use it for a long time.
 - Always make sure that the batteries making up a set are all of the same type.
 - Never combine new batteries with old ones.
 - Never dispose of batteries by incinerating them. Never short or disassemble batteries, and do not expose them to excessive heat.
 - Replace dead batteries as soon as possible.
 - Never attempt to recharge batteries.

Transport

- When transporting the instrument, always make sure to unplug the AC adaptor from the electrical outlet and confirm that all other external connections have been disconnected. Only then should the instrument be transported. If the above is not done, the cord may be damaged leading to possible fire or electrical shock.



Care

- Whenever caring, make sure to first unplug the AC adaptor from the electrical outlet. Also remove the instrument's batteries if battery power is being used.



Location

- Never locate the instrument in areas subject to high humidity or heavy accumulation of dust. Doing so may cause fire or electrical shock.
- Never locate the instrument in areas subject to grease splatters or steam, such as in a kitchen or near a humidifier. Doing so may cause fire or electrical shock.



Do not place keyboard on lacquered furniture.

- The instrument's silicone rubber feet may eventually blacken or scar lacquered surfaces. Use felt cloth pads to insulate the feet or preferably use a CASIO musical instrument stand designed for your keyboard.

Do not place heavy objects on the instrument.

- Do not place heavy objects on the instrument. This may cause the instrument to tip over or break resulting in injury.

Volume

- Very high volume levels can damage hearing. Avoid using the instrument at very high volume settings for long periods. Consult with a physician immediately if you experience impaired hearing or ringing in the ears.

Liquid Crystal Display (LCD) Precautions

- Avoid subjecting the keyboard's LCD to strong impact, which can crack or break the LCD's glass creating the danger of personal injury.
- Should the LCD glass ever crack or break, do not allow the liquid inside the LCD to come into contact with your skin, which can cause inflammation and reddening.
 - Should the LCD liquid get into your mouth, immediately wash out your mouth with water and then consult a physician.
 - Should the LCD liquid get in your eyes or on your skin, immediately flush with water for at least 15 minutes and then consult a physician.

Do not get onto the instrument or stand.*

- Do not crawl on top of the instrument or its optional stand. Particular caution is required in homes having small children. This may cause the instrument or stand to tip over and break resulting in injury.

Optional Stand*

- Carefully assemble the stand following the assembly instructions that come with it. Securely tighten all bolts, nuts, and fasteners, and make sure that you mount the instrument correctly onto the stand. Incorrectly or insufficiently tightening screws, or incorrectly mounting the instrument onto the stand can cause the stand to tip over or the instrument to fall off the stand, possibly leading to injury.

* The stand is available as an option.

Care of your keyboard

Avoid heat, humidity or direct sunlight.

Do not overexpose the instrument to direct sunlight, or place it near an air conditioner, or in any extremely hot place.

Do not use near a TV or radio.

This instrument can cause video or audio interference with TV and radio reception. If this happens, move the instrument away from the TV or radio.

Do not use lacquer, thinner or similar chemicals for cleaning.

Clean the keyboard with a soft cloth dampened in a weak solution of water and a neutral detergent. Soak the cloth in the solution and squeeze until it is almost dry.

Avoid use in areas subjected to temperature extremes.

Extremely high or low temperature can cause figures on the LCD screen to become dim and difficult to read. This condition should correct itself when the keyboard is brought back to normal temperature.

NOTE

You may notice lines in the finish of the case of this keyboard. These lines are a result of the molding process used to shape the plastic of the case. They are not cracks or breaks in the plastic, and are no cause for concern.



Contents

Welcome..... E-1

Main Features E-2

Safety Precautions E-3

Care of your keyboard E-5

Contents E-6

General Guide E-8

About the display E-9

Quick Reference E-10

Connections..... E-11

Phones/Output Terminal E-11

Connecting to a Computer
or Other Equipment E-11

Assignable jack Terminal E-11

Accessories and Options E-11

Power Supply..... E-12

Using batteries E-12

Using the AC Adaptor E-12

Auto Power Off E-13

Settings and Memory Contents E-13

Basic Operations E-14

To play the keyboard E-14

Selecting a Tone E-14

Using the Metronome E-15

Auto Accompaniment E-16

Selecting a Rhythm E-16

Playing a Rhythm E-16

Adjusting the Tempo E-16

Using Auto Accompaniment E-17

Using an Intro Pattern E-19

Using a Fill-in Pattern E-19

Using a Rhythm Variation E-19

Using a Fill-in Pattern with
a Variation Rhythm E-19

Synchro Starting Accompaniment
with Rhythm Play E-19

Finishing with an Ending Pattern E-20

Adjusting the Accompaniment
Volume E-20

Using One-touch Preset E-20

Playing a Built-in Tune E-21

To play back a Song Bank tune E-21

To play an Etude tune E-22

To play a Concert Piece tune E-22

Musical Information System E-22

Adjusting the Tempo E-23

To pause playback E-23

To fast reverse E-23

To fast forward E-23

To change the melody tone E-23

To play all tunes in succession E-23

3-Step Lesson E-24

- Step 1 – Master the timing. E-25
- Step 2 – Master the melody. E-25
- Step 3 – Play a normal speed. E-26

Memory Function E-27

- Tracks E-27
- Real-time Recording to Track 1 E-28
- Playing Back from Memory E-29
- Real-time Recording to Track 2 E-30
- Deleting the Contents of a Specific Track E-31

Keyboard Settings E-32

- Using Layer E-32
- Using Split E-32
- Using Layer and Split Together E-33
- Using Touch Response E-34
- Transposing the Keyboard E-34
- Tuning the Keyboard E-35

MIDI E-36

- What is MIDI? E-36
- General MIDI E-37
- Changing MIDI Settings E-37
- Messages E-39

Troubleshooting E-41

Specifications E-42

Appendix A-1

- Note Table A-1

Drum Assignment List A-3

Fingered Chord Chart A-4

Tone List A-6

Rhythm List A-7

MIDI Implementation Chart

General Guide

Key, button, and other names are indicated in the text of this manual using bold type.

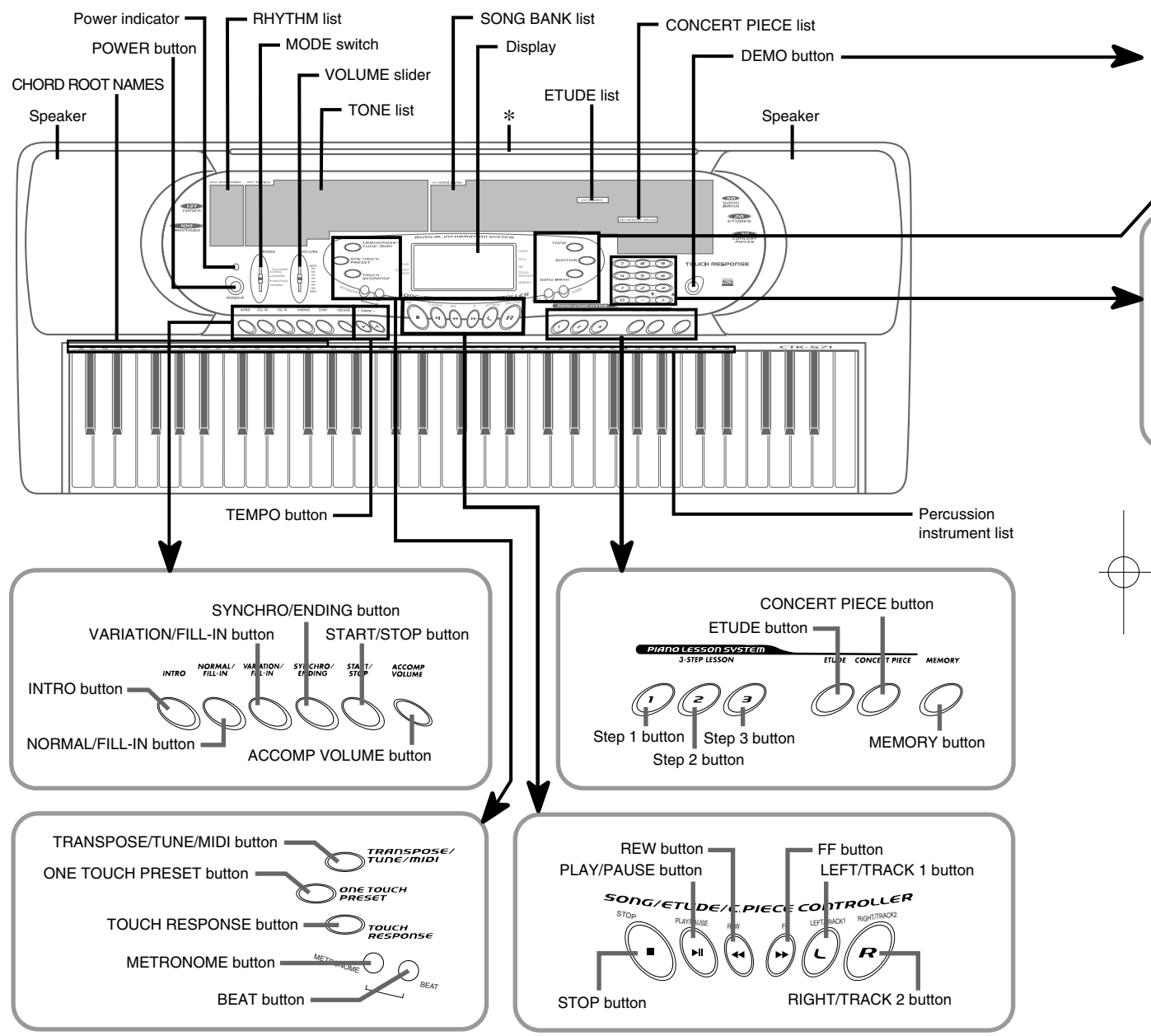

***Attaching the Score Stand**
Insert the score stand into the slot at the top of the keyboard as shown in the illustration.

Playing a Demo Tune

Pressing the DEMO button starts demo tune play, which plays the 100 built-in tunes in sequence. To stop demo tune play, press the DEMO, START/STOP, or STOP button.

NOTES

- Pressing [+] (forward) or [-] (back) skips to the next demo tune.
- You can change the tone setting of the keyboard (page E-14) before starting demo play, and then use that tone to play along on the keyboard.
- MIDI, Layer, and Split are disabled while a demo tune is playing.

Rear Panel

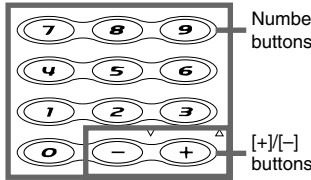
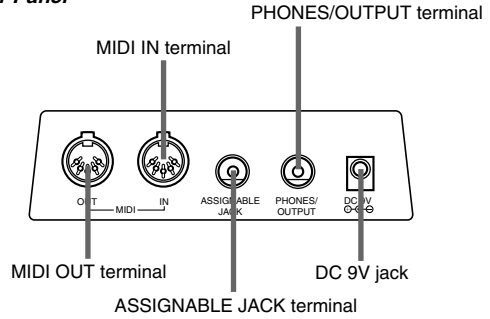

Number buttons

- For input of numbers to change a displayed number or setting.
- Negative values cannot be input using the number buttons. Use [+] (increase) and [-] (decrease) instead.

[+]/[-] buttons

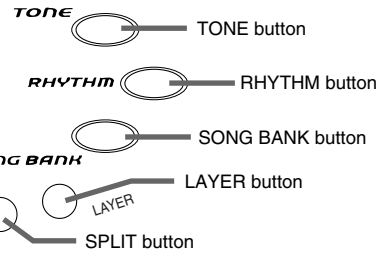

About the display

2. This area shows tone number and name, rhythm number and name, and tune number and name. It also shows other information when using the memory function and other functions. Indicators also appear here to show what kind of data is displayed: TONE (tone data), RHYTHM (rhythm data), SONG BANK (Song Bank data).

1. A dot and piano mark appears next to the group that is in use: Etude, Concert Piece.

8. Uses a graphic keyboard to show notes being played from built-in tunes, on the keyboard, or from memory, chord forms, and MIDI receive data.

ETUDE
CONCERT
PIECE

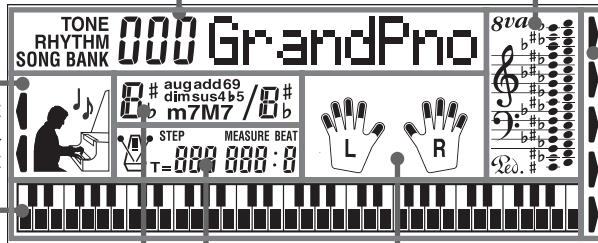

LAYER
SPLIT
GM
TOUCH
RESPONSE
MEMORY

4. A pointer or indicator appears next to a function that is in use: touch response, General MIDI Mode, layer, split, memory, step.

7. This area shows chord names during Auto Accompaniment and Song Bank play.

6. This area shows measure number, beat number, a graphic metronome, and tempo value (beats per minute) during rhythm and Auto Accompaniment play, and when using memory. It also shows the step number when using the 3-step lesson.

5. This area shows fingerings, dynamic marks, and other finger information during 3-step lesson and tune play. The letters "L" (left) and "R" (right) appear to indicate left and right hand Auto Accompaniment parts and memory tracks.

3. This area is a staff notation display that shows notes being played from built-in tunes, on the keyboard, or from memory, chord forms, and MIDI receive data.*1 Notes in the range F#6 to C7 are shown in the staff notation display one octave lower, along with an octave up mark (*8va*).*2 If you are using a pedal, a pedal mark (ped.) appears here whenever you press the pedal.
*1 Received notes outside the range of C2 to C7 do not appear on the display.
*2 Notes in the range of C2 through B2 are not shown while the octave up mark (*8va*) is on the display.

NOTE

Display examples shown in this User's Guide are intended for illustrative purposes only. The actual text and values that appear on the display may differ from the examples shown in this User's Guide.

Quick Reference

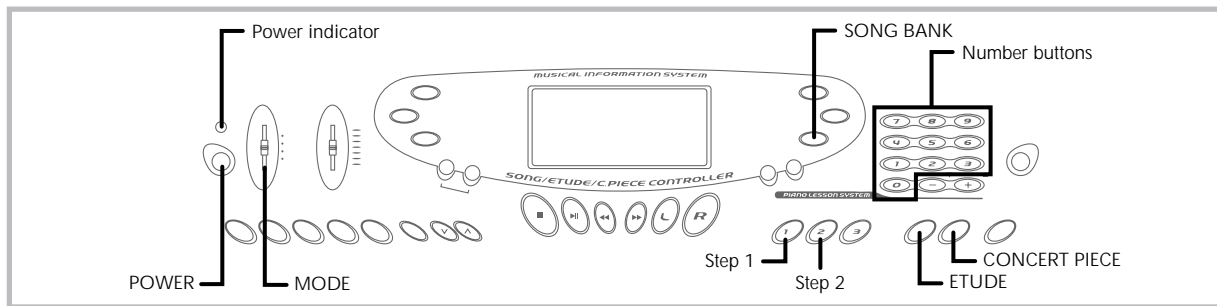

This section provides a quick overview of keyboard operation using steps one and two of the 3-step lesson feature. With the 3-step lesson feature, the on-screen keyboard guide keys light to show the next note of the tune.

To play the keyboard

1. Press the **POWER** button to turn on power.
 - This causes the power indicator to light.



2. Set the **MODE** switch to **NORMAL**.

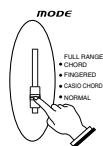

3. Press the **SONG BANK** button.



4. Find the tune you want to play in the **SONG BANK List**, and then use the **number buttons** to input its two-digit number.

Example: To select "42 ALOHA OE", input 4 and then 2.



5. Press the **Step 1** button or **Step 2** button.
 - The keyboard sounds a count beat and waits for you to play something on the keyboard. The keys that you need to press first flash on the display.
6. Play the melody along with the selected tune's accompaniment.
 - Play in accordance with the keyboard keys, fingerings and notes that appear on the display.

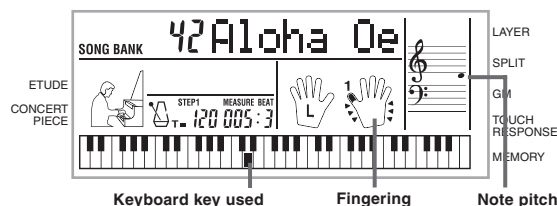

7. To stop play at any time, press the **STOP** or **START/STOP** button.

If you selected lesson Step 1

- Play the notes on the keyboard.
- A sub-melody (obbligato) plays in time with the melody.
- With Step 1, the correct melody note is played no matter which keyboard key you press.

If you selected lesson Step 2

- Play the correct notes on the keyboard.
- While an on-screen keyboard guide key is lit, press the corresponding key on the actual keyboard. In the case of an Etude or Concert Piece tune, the keyboard guide indication turns off when you press a keyboard key, and the on-screen keyboard guide key lights for the next note to be played.
- A sub-melody (obbligato) plays in time with the melody, as long as you press the correct keyboard keys.

To play an Etude or Concert Piece tune

1. When you get to step 3 of the above procedure, press the **ETUDE** or **CONCERT PIECE** button in place of the **SONG BANK** button.
2. In the list of titles associated with the button you pressed (**ETUDE** or **CONCERT PIECE**), find the piece you want to play and then use the **number buttons** to input its two-digit number.
3. Next, continue from step 5 of the above procedure.

Connections

Phones/Output Terminal

Before connecting headphones or other external equipment, be sure to first turn down the volume settings of the keyboard and the connected equipment. You can then adjust volume to the desired level after connections are complete.

[Rear Panel]

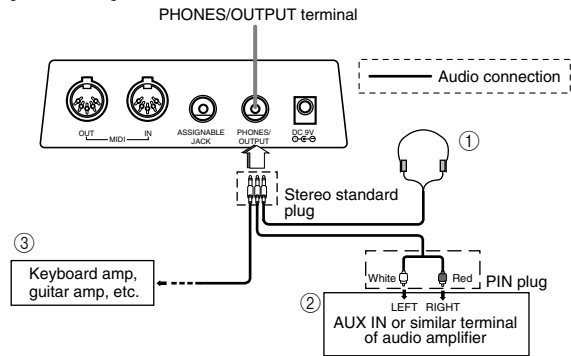

Connecting Headphones (Figure 1)

Connecting headphones cuts off output from the keyboard's built-in speakers, so you can play even late at night without disturbing anyone.

Audio Equipment (Figure 2)

Connect the keyboard to a audio equipment using a commercially available connecting cord with a standard plug on one end and two PIN plugs on the other end. Note that the standard plug you connect to the keyboard must be a stereo plug, otherwise you will be able to output only one of stereo channels. In this configuration, you normally set the input selector of the audio equipment to the terminal (usually marked AUX IN or something similar) where the cord from the keyboard is connected. See the user documentation that comes with your audio equipment for full details.

Musical Instrument Amplifier (Figure 3)

Use a commercially available connecting cord to connect the keyboard to a musical instrument amplifier.

NOTE

Be sure to use a connecting cord that has a stereo standard plug on the end you connect to the keyboard, and a connector that provides dual channel (left and right) input to the amplifier to which you are connecting. The wrong type of connector at either end can cause one of the stereo channels to be lost.

When connected to a musical instrument amplifier, set the volume of the keyboard to a relatively low level and make output volume adjustments using the amplifier's controls.

Connection Example

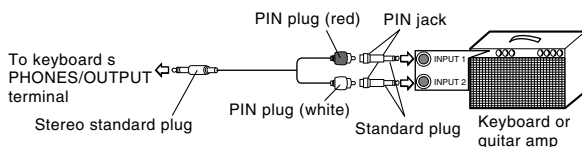

Connecting to a Computer or Other Equipment

You can also connect the keyboard to a computer or sequencer. See "MIDI" on page E-36 for details.

Assignable jack Terminal

You can connect an optional sustain pedal (SP-2 or SP-10) to the ASSIGNABLE JACK terminal to enable the capabilities described below.

For details on how to select the pedal function you want, see "ASSIGNABLE JACK" on page E-39.

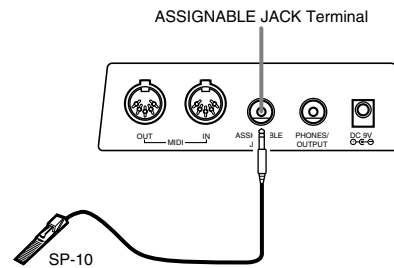

Sustain Pedal

- With piano tones, depressing the pedal causes notes to linger, much like a piano's damper pedal.
- With organ tones, depressing the pedal causes notes to continue to sound until the pedal is released.

Sostenuto Pedal

- As with the sustain pedal function described above, depressing the sostenuto pedal causes notes to be sustained.
- This difference between a sostenuto pedal and sustain pedal is the timing. With a sostenuto pedal, you press the keys and then depress the pedal before you release the keys. Only the notes that are sounding when the pedal is depressed are sustained.

Soft Pedal

Depressing the pedal softens the sound of the notes being played.

Rhythm Start/Stop Pedal

In this case, the pedal performs the same functions as the START/STOP button.

Accessories and Options

Use only the accessories and options specified for this keyboard. Use of non-authorized items creates the danger of fire, electrical shock, and personal injury.

Power Supply

This keyboard can be powered by current from a standard household wall outlet (using the specified AC adaptor) or by batteries. Always make sure you turn the keyboard off whenever you are not using it.

Using batteries

Always make sure you turn off the keyboard before loading or replacing batteries.

To load batteries

1. Remove the battery compartment cover.

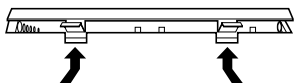

2. Load 6 D-size batteries into the battery compartment.
 - Make sure that the positive (+) and negative (-) ends are facing correctly.

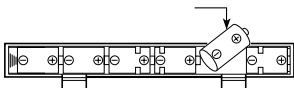

3. Insert the tabs on the battery compartment cover into the holes provided and close the cover.

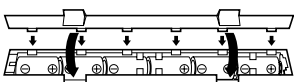

The keyboard may not function correctly if you load or replace batteries with power turned on. If this happens, turning the keyboard off and then back on again should return functions back to normal.

Important Battery Information

- The following shows the approximate battery life.
Manganese batteries 6 hours
The above value is standard battery life at normal temperature, with the keyboard volume at medium setting. Temperature extremes or playing at very loud volume settings can shorten battery life.
- Any of the following symptoms indicate low battery power. Replace batteries as soon as possible whenever any of the following occurs.
 - Dim power supply indicator
 - Instrument does not turn on
 - Dim, difficult to read display
 - Abnormally low speaker/headphone volume
 - Distortion of sound output
 - Occasional interruption of sound when playing at high volumes
 - Sudden power failure when playing at high volumes
 - Dimming of the display when playing at high volume
 - Continued sound output even after you release a key
 - A totally different tone may sound
 - Abnormal rhythm pattern and demo tune play
 - Loss of power, sound distortion, or low volume when playing from a connected computer or MIDI device

IMPORTANT!

Improper handling of batteries can cause them to burst and leak, which creates the danger of personal injury or damage due to contact with battery acid. Be sure to note the following important precautions.

- Always make sure that the positive (+) and negative (-) poles are facing correctly as indicated inside the battery compartment.
- To avoid damage caused by leaking batteries, be sure to remove batteries from the keyboard whenever you leave it unattended for long periods (such as when leaving on a trip).
- Never mix batteries of different types.
- Never mix old batteries with new ones.
- Never discard batteries by incinerating them, do not allow their poles to be shorted (connected to each other), never take batteries apart, and do not expose batteries to direct heat.
- Replace batteries as soon as possible after any sign they are getting weak.
- Never attempt to recharge batteries.

Using the AC Adaptor

Make sure that you use only the AC adaptor specified for this keyboard.

Specified AC Adaptor: AD-5

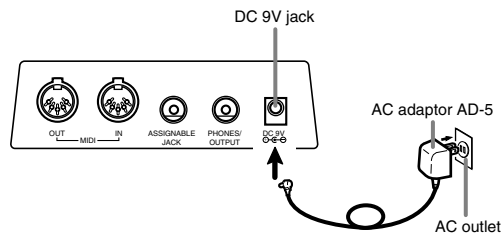

Also note the following important warnings and precautions when using the AC adaptor.

WARNING!

- Take care to avoid any damage to or breakage of the power cord. Never place any heavy objects on the power cord or expose it to direct heat. Doing so creates the danger of power cord damage, fire, and electrical shock.
- Use only the specified AC adaptor. Use of another type of adaptor creates the danger of fire and electrical shock.

CAUTION!

- For safety sake, be sure to unplug the AC adaptor from the wall outlet whenever leaving the keyboard unattended for a long time (such as when leaving on a trip).
- Always turn off the keyboard and unplug the AC adaptor from the wall outlet when you are not using the keyboard.

IMPORTANT!

- Make sure that the keyboard is turned off before connecting or disconnecting the AC adaptor.
- Using the AC adaptor for a long time can cause it to become warm to the touch. This is normal and does not indicate malfunction.

Auto Power Off

When you are using battery power, keyboard power turns off automatically whenever you leave it on without performing any operation for about 6 minutes. When this happens, press the POWER button to turn power back on.

NOTE

Auto Power Off is disabled (it does not function) when you are using the AC adaptor to power the keyboard.

To disable Auto Power Off

Hold down the TONE button while turning on the keyboard to disable Auto Power Off.

- When this function is turned off, the keyboard does not turn off automatically no matter how long it is left with no operation being performed.
- Auto Power Off is enabled again when you manually turn off power and then turn it back on again.

Settings and Memory Contents

Settings

Tone, rhythm, and other “main keyboard settings” in effect when power is turned off manually with the POWER button or automatically by Auto Power Off remain in effect when you next turn power back on.

Main Keyboard Settings

Main keyboard settings are: tone number, layer, split, split point, touch response, rhythm number, tempo, accompaniment volume, General MIDI mode on/off, accomp MIDI OUT on/off, Assignable jack setting, keyboard channel, and tune number.

Memory Contents

In addition to the above settings, data stored using the memory function is also retained.

Electrical Power

The settings and memory data described above are retained as long as the keyboard is being supplied with electrical power. Unplugging the AC adaptor when batteries are not loaded or when loaded batteries are dead cuts off the keyboard’s electrical power supply. This causes all settings to be initialized to their factory defaults and clears all data stored in memory.

Power Requirements

Note the following precautions whenever you want to ensure that current keyboard settings and memory contents are not lost.

- Make sure the keyboard is being supplied power through the AC adaptor before replacing its batteries.
- Before unplugging the AC adaptor, make sure that fresh batteries are loaded in the keyboard.
- Make sure that keyboard power is turned off before replacing batteries or unplugging the AC adaptor.

Basic Operations

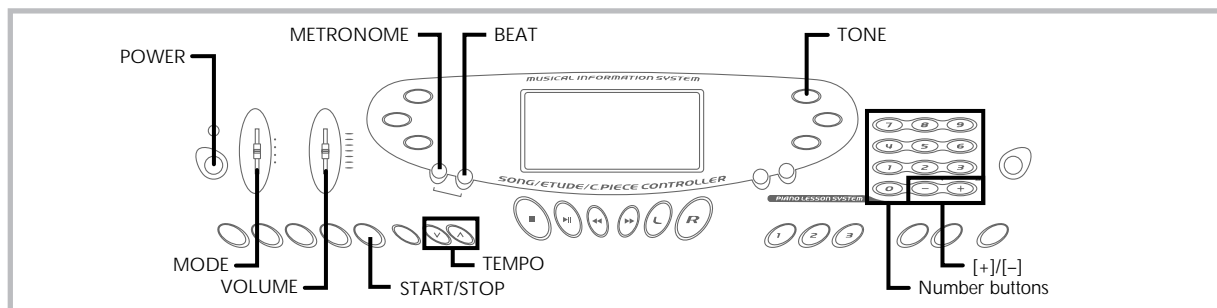

This section provides information on performing basic keyboard operations.

To play the keyboard

1. Press the **POWER** button to turn the keyboard on.
2. Set the **MODE** switch to **NORMAL**.
3. Use the **VOLUME** slider to set the volume to a relatively low level.
4. Play something on the keyboard.

Selecting a Tone

This keyboard comes with 137 built-in tones. Use the following procedure to select the tone you want to use.

To select a tone

1. Find the tone you want to use in the keyboard's tone list and note its tone number.
2. Press the **TONE** button.



Indicator appears

3. Use the **number buttons** to input the three digit tone number for the tone you want to select.

Example: To select "032 ACOUSTIC BASS", input 0, 3 and then 2.



NOTES

- Always input all three digits for the tone number, including leading zeros (if any). If you input one or two digits and stop, the display will automatically clear your input after a few seconds.
- You can also increment the displayed tone number by pressing [+], and decrement it by pressing [-].
- The names of tone numbers 080 through 103 and 112 through 127 are not marked on the keyboard console. See the "Tone List" (page A-6) for details.
- When one of the drum sets is selected (tone numbers 128 through 136), each keyboard key is assigned a different percussion sound. See page A-3 for details.

Polyphony

The term polyphony refers to the maximum number of notes you can play at the same time. The keyboard has 24-note polyphony, which includes the notes you play as well as the rhythms and auto-accompaniment patterns that are played by the keyboard. This means that when a rhythm or auto-accompaniment pattern is being played by the keyboard, the number of notes (polyphony) available for keyboard play is reduced. Also note that some of the tones offer only 12-note polyphony.

- When rhythm or auto accompaniment is playing, the number of sounds simultaneously played is reduced.

Digital Sampling

A number of the tones that are available with this keyboard have been recorded and processed using a technique called digital sampling. To ensure a high level of tonal quality, samples are taken in the low, mid, and high ranges and then combined to provide you with sounds that are amazingly close to the originals. You may notice very slight differences in volume or sound quality for some tones when you play them at different positions on the keyboard. This is an unavoidable result of multiple sampling, and it is not a sign of malfunction.

Using the Metronome

The metronome feature of this keyboard produces a bell sound for the first beat of each measure, followed by click sounds for each successive beat of the measure. It is the perfect tool for practicing tunes without accompaniment (rhythm).

To start the metronome

1. Press the **METRONOME** button to start sounding the metronome.

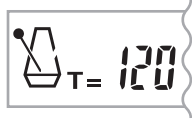

2. Press the **BEAT** button and then use the **number buttons** or **[+]** and **[-]** to change the number of beats per measure.
 - You can specify the number of beats per measure a value from 1 to 6.



NOTE

The bell (indicating the first beat of a measure) does not sound while one beat per measure is specified. All beats are indicated by a click sound. This setting lets you practice with a steady beat, without worrying about how many beats there are in each measure.

3. Use the **TEMPO** buttons to set the tempo.
 - Press \wedge to increase the tempo (make it faster) or \vee to decrease it (make it slower).

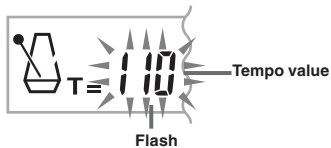

NOTES

- While the tempo value is flashing, you can also use the number buttons or **[+]** and **[-]** to input a three-digit value. Note that you must input leading zeros, so 90 is input as 090.
- Pressing both the \wedge and \vee TEMPO buttons at the same time automatically returns the currently selected rhythm to its default tempo.

4. To turn off the metronome, press the **METRONOME** or **START/STOP** button.

NOTES

- The metronome is disabled whenever you are using Step 1 or Step 2 of the 3-step lesson.
- Starting play of a two-hand tune or Step 3 of the 3-step lesson while the metronome is operating or activating the metronome while either of the two above operations is already in progress causes the metronome to sound in time with the Auto Accompaniment played by the keyboard. At this time, the tempo of the metronome beat changes to that of the default tempo for the Auto Accompaniment being played.

Auto Accompaniment

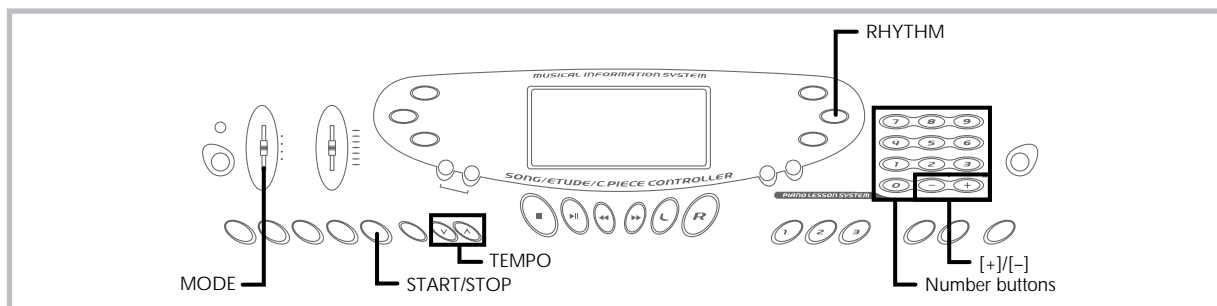

This keyboard automatically plays bass and chord parts in accordance with the chords you finger. The bass and chord parts are played using sounds and tones that are automatically selected to select the rhythm you are using. All of this means that you get full, realistic accompaniments for the melody notes you play with your right hand, creating the mood of an one-person ensemble.

Selecting a Rhythm

This keyboard provides you with 100 exciting rhythms that you can select using the following procedure.

To select a rhythm

1. Find the rhythm you want to use in the "Rhythm List" (page A-7) and note its rhythm number.
2. Press the **RHYTHM** button.



3. Use the **number buttons** to input the two digit rhythm number for the rhythm you want to select.
Example: To select "76 RHUMBA", input 7 and then 6.



NOTE

You can also increment the displayed rhythm number by pressing [+], and decrement it by pressing [-].

Playing a Rhythm

Use the following procedure to start and stop rhythm play.

To play a rhythm

1. Set the **MODE** switch to NORMAL.
2. Press the **START/STOP** button to start play of the currently selected rhythm.
3. To stop rhythm play, press the **START/STOP** button again.

NOTE

All of the keyboard keys are melody keys while the MODE switch is set to NORMAL.

Adjusting the Tempo

The tempo (beats per minute) can be set to a value in the range of 40 to 255. The tempo value you set is use for Song Bank, 3-step lesson, and Auto Accompaniment chord play, as well as playback from memory and metronome operation.

To set the tempo

Use the **TEMPO** buttons to set the tempo.

- ^ : Increase the tempo value.
- v : Decreases the tempo value.

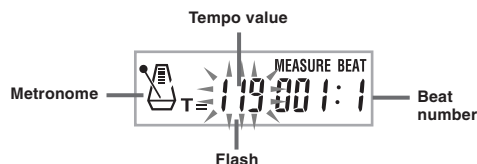

NOTES

- While the tempo value is flashing, you can also use the number buttons or [+], and [-] to input a three-digit value. Note that you must input leading zeros, so 90 is input as 090.
- Pressing both the ^ and v TEMPO buttons at the same time automatically returns the currently selected rhythm to its default tempo.

Using Auto Accompaniment

The following procedure describes how to use the keyboard's Auto Accompaniment feature. Before starting, you should first select the rhythm you want to use and set the tempo of the rhythm to the value you want.

To use Auto Accompaniment

1. Set the **MODE** switch to CASIO CHORD, FINGERED, or FULL RANGE CHORD.
2. Press the **START/STOP** button to start play of the currently selected rhythm.
3. Play a chord.
 - The actual procedure you should use to play a chord depends on the current MODE switch position. Refer to the following pages for details on chord play.

CASIO CHORD On this page
 FINGERED Page E-18
 FULL RANGE CHORD Page E-18

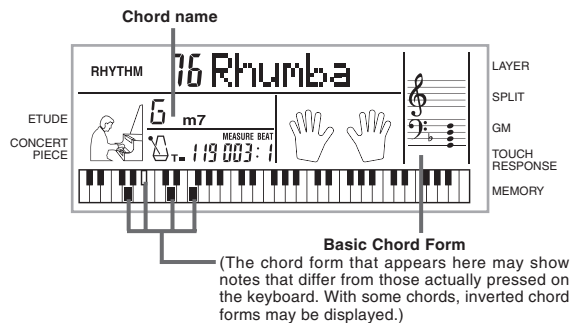

4. To stop Auto Accompaniment play, press the **START/STOP** button again.

CASIO CHORD

This method of chord play makes it possible for anyone to easily play chords, regardless of previous musical knowledge and experience. The following describes the CASIO CHORD "Accompaniment keyboard" and "Melody keyboard", and tells you how to play CASIO CHORDS.

CASIO CHORD Accompaniment Keyboard and Melody Keyboard



NOTE

The accompaniment keyboard can be used for playing chords only. No sound will be produced if you try playing single melody notes on the accompaniment keyboard.

Chord Types

CASIO CHORD accompaniment lets you play four types of chords with minimal fingering.

Chord Types	Example
Major chords Major chord names are marked above the keys of the accompaniment keyboard. Note that the chord produced when you press an accompaniment keyboard does not change octave, regardless of which key you use to play it.	C Major (C)
Minor chords (m) To play a minor chord, keep the major chord key depressed and press any other accompaniment keyboard key located to the right of the major chord key.	C minor (Cm)
Seventh chords (7) To play a seventh chord, keep the major chord key depressed and press any other two accompaniment keyboard keys located to the right of the major chord key.	C seventh (C7)
Minor seventh chords (m7) To play a minor seventh chord, keep the major chord key depressed and press any other three accompaniment keyboard keys located to the right of the major chord key.	C minor seventh (Cm7)

NOTE

It makes no difference whether you press black or white keys to the right of a major chord key when playing minor and seventh chords.

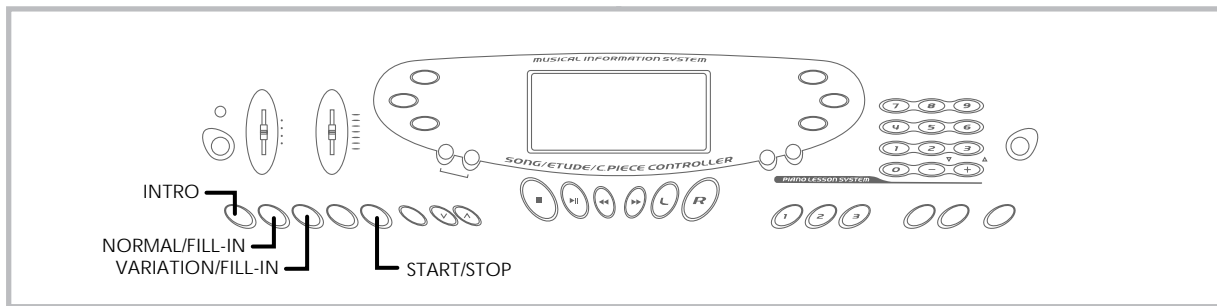

FINGERED

FINGERED provides you with a total of 15 different chord types. The following describes the FINGERED "Accompaniment keyboard" and "Melody keyboard", and tells you how to play a C-root chord using FINGERED.

FINGERED Accompaniment Keyboard and Melody Keyboard

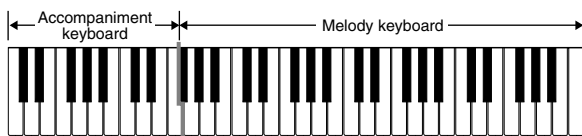

NOTE

The accompaniment keyboard can be used for playing chords only. No sound will be produced if you try playing single melody notes on the accompaniment keyboard.

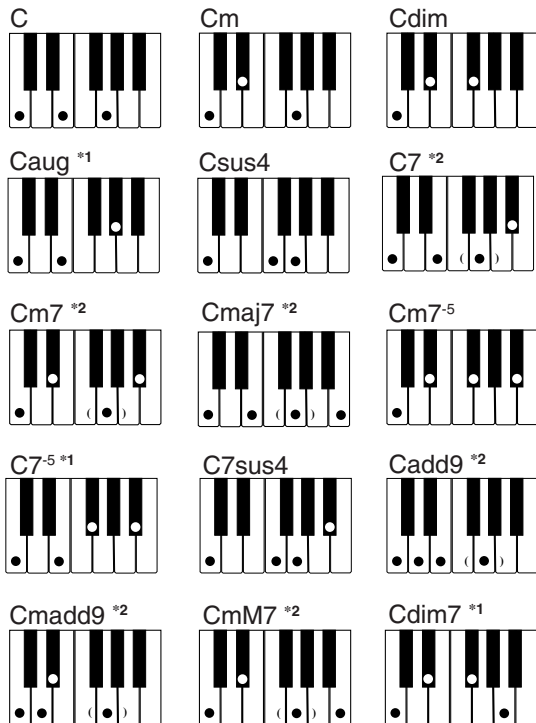

See the FINGERED Chord Chart on page A-4 for details on playing chords with other roots.

- *1: Inverted fingerings cannot be used. The lowest note is the root.
- *2: The same chord can be played without pressing the 5th G.

NOTES

- Except for the chords specified in note *1 above, inverted fingerings (i.e. playing E-G-C or G-C-E instead of C-E-G) will produce the same chords as the standard fingering.
- Except for the exception specified in note *2 above, all of the keys that make up a chord must be pressed. Failure to press even a single key will not play the desired FINGERED chord.

FULL RANGE CHORD

This accompaniment method provides a total of 38 different chord types: the 15 chord types available with FINGERED plus 23 additional types. The keyboard interprets any input of three or more keys that matches a FULL RANGE CHORD pattern to be a chord. Any other input (that is not a FULL RANGE CHORD pattern) is interpreted as melody play. Because of this, there is no need for a separate accompaniment keyboard, so the entire keyboard, from end to end, can be used for both melody and chords.

FULL RANGE CHORD Accompaniment Keyboard and Melody Keyboard

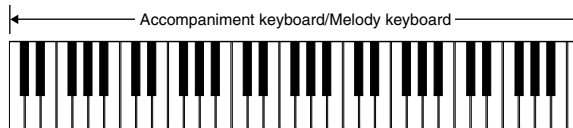

< Chords Recognized by This Keyboard >

Chord Types	Number of Types
Corresponding FINGERED Chord	15 (on this page)
Other Chords	<p>23 The following are examples of chords that use C as the bass note.</p> <p>C₆ • Cm₆ • C₆₉</p> <p>$\frac{C^\#}{C}$ • $\frac{D}{C}$ • $\frac{E}{C}$ • $\frac{F}{C}$ • $\frac{G}{C}$ • $\frac{A}{C}$ • $\frac{B}{C}$</p> <p>$\frac{B}{C}$ • $\frac{C^\#m}{C}$ • $\frac{Dm}{C}$ • $\frac{Fm}{C}$ • $\frac{Gm}{C}$ • $\frac{Am}{C}$ • $\frac{Bm}{C}$</p> <p>$\frac{Dm7-5}{C}$ • $\frac{A_7}{C}$ • $\frac{F_7}{C}$ • $\frac{Fm_7}{C}$ • $\frac{Gm_7}{C}$ • $\frac{A_{add9}}{C}$</p>

Example: To play the chord C major.

Any of the fingerings shown in the illustration below will produce C major.

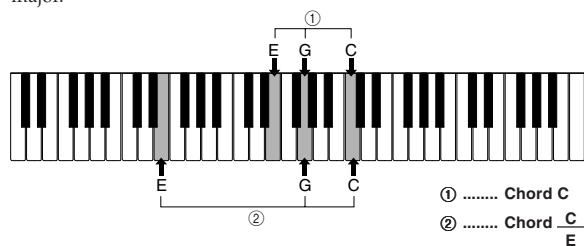

NOTES

- As with the FINGERED mode (page E-18), you can play the notes that form a chord in any combination (①).
- When the composite notes of a chord are separated by 6 or more notes, the lowest sound becomes the bass (②).

Music Example >

Tone: 016, Rhythm: 05, Tempo: 070

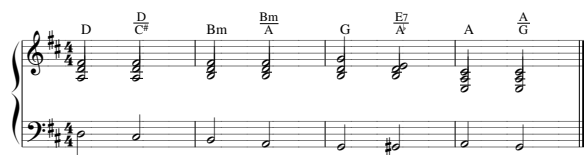

Using an Intro Pattern

This keyboard lets you insert a short intro into a rhythm pattern to make startup smoother and more natural.

The following procedure describes how to use the Intro feature. Before starting, you should first select the rhythm you want to use, and set the tempo.

To insert an intro

Press the **INTRO** button to start the selected rhythm with an intro pattern.

- With the above setup, the intro pattern is played and the auto accompaniment with intro pattern starts as soon as you play chords on the accompaniment keyboard.

NOTES

- The standard rhythm pattern starts to play after the intro pattern is complete.
- Pressing the VARIATION/FILL-IN button while an intro pattern is playing causes the variation pattern to sound after the intro pattern is complete.
- Pressing the SYNCHRO/ENDING button while an intro pattern is playing causes the ending pattern to sound after the intro pattern is complete.

Using a Fill-in Pattern

Fill-in patterns let you momentarily change the rhythm pattern to add some interesting variation to your performances.

The following procedure describes how to use the Fill-in feature.

To insert a fill-in

1. Press the **START/STOP** button to start rhythm play.
2. Press the **NORMAL/FILL-IN** button to insert a fill-in pattern for the rhythm you are using.

NOTE

The fill-in pattern does not play if you press the **NORMAL/FILL-IN** button while an intro pattern is playing.

Using a Rhythm Variation

In addition to the standard rhythm pattern, you can also switch to a secondary "variation" rhythm pattern for a bit of variety.

To insert the variation rhythm pattern

1. Press the **START/STOP** button to start rhythm play.
2. Press the **VARIATION/FILL-IN** button to switch to the variation pattern for the rhythm you are using.

NOTE

To switch back to the standard rhythm pattern, press the **NORMAL/FILL-IN** button.

Using a Fill-in Pattern with a Variation Rhythm

You can also insert a fill-in pattern while a variation rhythm pattern is playing.

To insert a fill-in into a rhythm variation

While a variation rhythm pattern is playing, press the **VARIATION/FILL-IN** button to insert a fill-in pattern for the variation rhythm you are using.

Synchro Starting Accompaniment with Rhythm Play

You can set up the keyboard to start rhythm play at the same time you play the accompaniment on the keyboard.

The following procedure describes how to use synchro start. Before starting, you should first select the rhythm you want to use, set the tempo, and use the **MODE** switch to select the chord play method you want to use (**NORMAL**, **CASIO CHORD**, **FINGERED**, **FULL RANGE CHORD**).

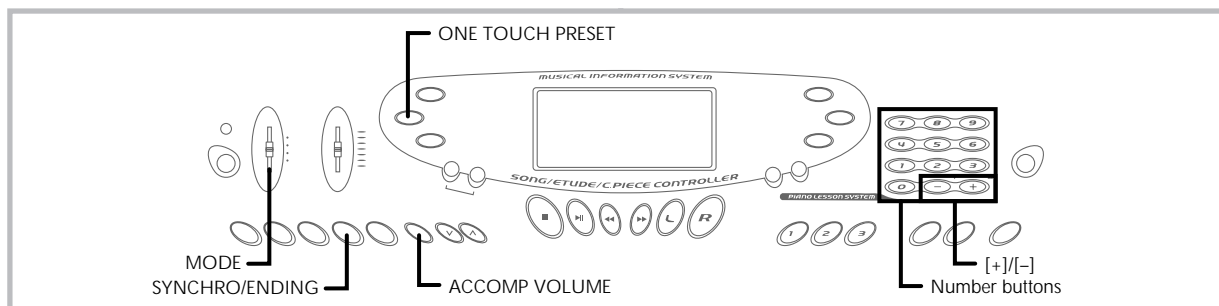

To use synchro start

1. Press the **SYNCHRO/ENDING** button to put the keyboard into synchro start standby.

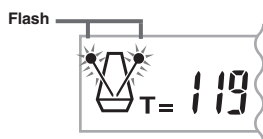

2. Play a chord and the rhythm pattern starts to play automatically.

NOTES

- If the MODE switch is set to NORMAL, only the rhythm plays (without a chord) when you play on the accompaniment keyboard.
- If you press the INTRO button before playing anything on the keyboard, the rhythm starts automatically with an intro pattern when you play something on the accompaniment keyboard.
- Pressing the VARIATION/FILL-IN button before playing anything on the keyboard causes play to start with the variation pattern when something is played on the keyboard.
- To cancel synchro start standby, press the SYNCHRO/ENDING button one more time.

Finishing with an Ending Pattern

You can end your performances with an ending pattern that brings the rhythm pattern you are using to a natural-sounding conclusion. The following procedure describes how to insert an ending pattern. Note that the actual ending pattern played depends on the rhythm pattern you are using.

To finish with an ending pattern

While the rhythm is playing, press the **SYNCHRO/ENDING** button.

- This causes the ending pattern to play which brings rhythm accompaniment to an end.
- The timing when the ending pattern starts depends on when you press the SYNCHRO/ENDING button. If you press the button before the second beat of the current measure, the ending pattern starts playing immediately. Pressing the button at any point in the measure after the second beat results in the ending pattern playing from the beginning of the following measure.

Adjusting the Accompaniment Volume

You can adjust the volume of the accompaniment parts as a value in the range of 000 (minimum) to 127.

1. Press the **ACCOMP VOLUME** button.

Current accompaniment volume setting



2. Use the **number buttons** or the **[+]/[-]** buttons to change the current volume setting value.

Example: 110



NOTES

- The current accompaniment volume value that appears in Step 1 automatically clears from the display if you do not input anything within about five seconds.
- Pressing [+] and [-] buttons at the same time automatically sets an accompaniment volume of 075.

Using One-touch Preset

One-touch preset automatically makes the settings listed below in accordance with the rhythm pattern you are using.

- Keyboard tone
- Layer, Split, or Layer Split on/off
- Layered tone (when layer is turned on), split tone (when split is turned on), or layered split tone (when layer and split are turned on)
- Tempo
- Accompaniment volume

To use one-touch preset

1. Select the rhythm you want to use.
2. Use the **MODE** button to select the accompaniment mode you want to use.
3. Press the **ONE TOUCH PRESET** button.
 - This automatically makes the one-touch preset settings in accordance with the rhythm you selected.
4. Play a chord and the rhythm pattern starts to play automatically.
 - Accompaniment is played using the one touch preset settings.

Playing a Built-in Tune

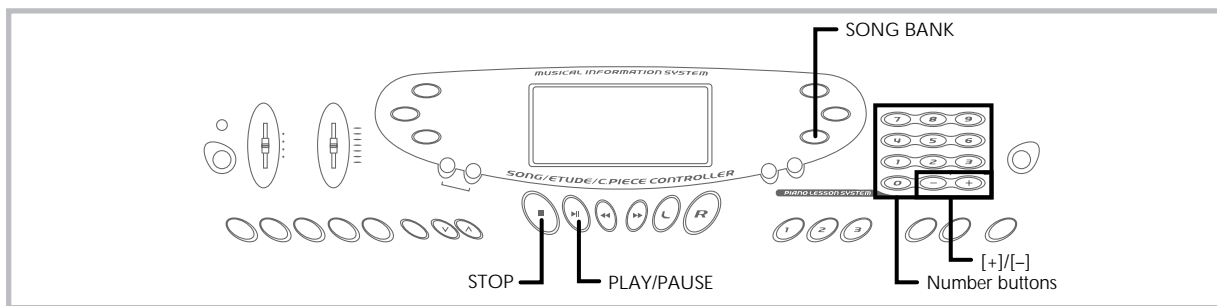

A selection of 100 tunes come built-in for your listening enjoyment or play along fun. You can turn off the left-hand or right-hand part to practice with the remaining part, and the display even shows you what keys to press and which fingers you should use.

There are three built-in tune groups, which are listed below.

- Song Bank: 50 Auto Accompaniment tunes
- Etude: 20 piano lesson tunes
- Concert Piece: 30 piano tunes

To play back a Song Bank tune

1. Find the tune you want to play in the **SONG BANK List**, and note its number.
2. Adjust the main volume and accomp volume.
3. Press the **SONG BANK button** to enter the Song Bank Mode.



4. Use the **number buttons** to input the tune's two-digit number.
Example: To select "42 ALOHA OE", input 4 and then 2.

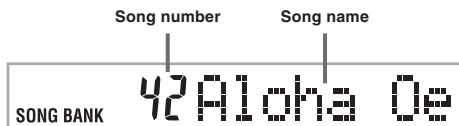

NOTES

- Tune Number 00 is the initial default Song Bank tune setting whenever you turn on keyboard power.
- You can also increment the displayed tune number by pressing [+], and decrement is by pressing [-].

5. Press the **PLAY/PAUSE button** to start play of the tune.

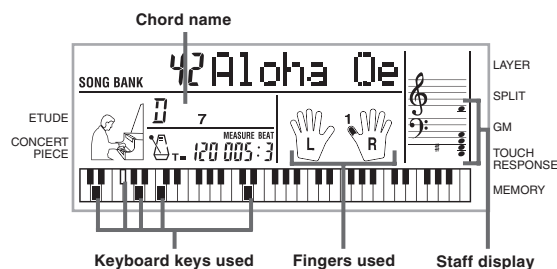

6. Press the **STOP button** to stop playback of the Song Bank tune.

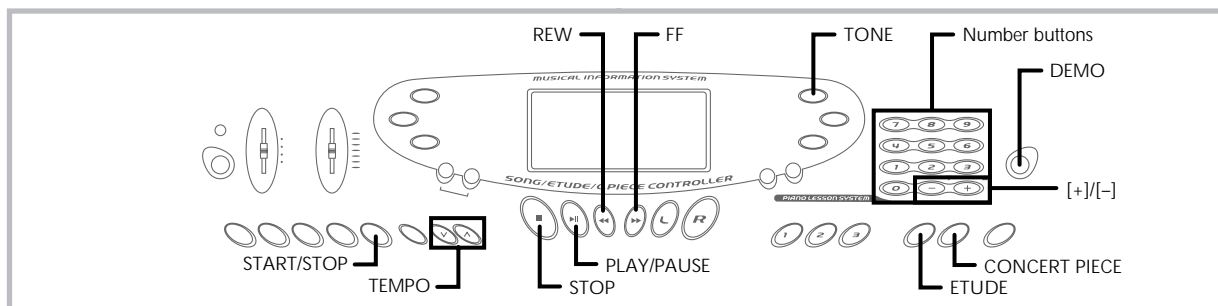

To play an Etude tune

1. Find the tune you want to play in the ETUDE List, and note its number.
2. Press the **ETUDE** button to specify the Etude group.

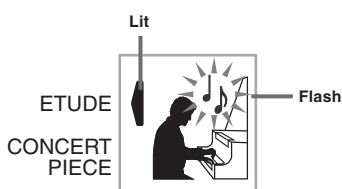

3. Use the **number buttons** to input the two-digit tune number you looked up in step 1.
Example: To select tune number 08 (Ode To Joy), input 0 and then 8.



NOTE

You can also change the displayed tune number using the [+] and [-] buttons.

4. Press the **PLAY/PAUSE** button to start playback.
5. To stop playback, press the **STOP** button.

To play a Concert Piece tune

1. Find the tune you want to play in the CONCERT PIECE List, and note its number.
2. Press the **CONCERT PIECE** button to specify the Concert Piece group.



3. Use the **number buttons** to input the two-digit tune number you looked up in step 1.
Example: To select tune number 22 (FÜR ELISE), input 2 and then 2.



NOTE

You can also change the displayed tune number using the [+] and [-] buttons.

4. Press the **PLAY/PAUSE** button to start playback.
5. To stop playback, press the **STOP** button.

NOTE

Pressing the ETUDE button or CONCERT PIECE button changes the tone to grand piano (Tone Number 000).

Musical Information System

When the keyboard is playing one of its built-in tunes, the display shows a variety of information about the tune.

Example: Display during Song Bank play

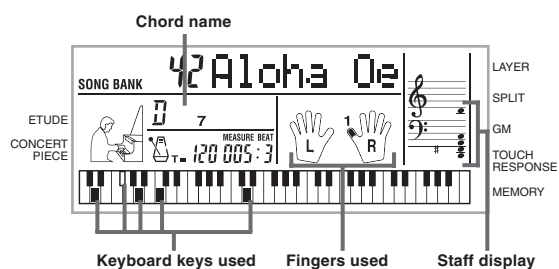

NOTE

Chord names are not displayed for Etude and Concert Piece tunes.

Adjusting the Tempo

Each tune has a preset default tempo (beats per minute) that is set automatically whenever you select a tune. While the tune is playing, you can change the tempo setting to a value in the range of 40 to 255.

To set the tempo

Use the **TEMPO** buttons to set the tempo.

∧ : Increases the tempo value.

∨ : Decreases the tempo value.

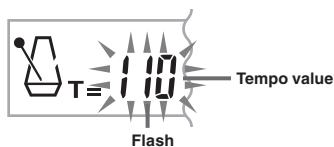

NOTES

- While the tempo value is flashing, you can also use the number buttons or [+] and [-] to input a three-digit value. Note that you must input leading zeros, so 90 is input as 090.
- Pressing both the ∧ and ∨ TEMPO buttons at the same time automatically returns the currently selected rhythm to its default tempo.
- Etude and Concert Piece tunes have tempo changes part way through in order to produce specific musical effects. Note that the tempo setting automatically returns to the default whenever a tempo change occurs within one of these tunes.

To pause playback

1. Press the **PLAY/PAUSE** button while a tune is playing to pause it.
2. Pressing the **PLAY/PAUSE** button again resumes play from the point where it was paused.

NOTE

After you press STOP to stop playback, pressing PLAY/PAUSE restarts play from the beginning of the tune.

To fast reverse

1. While a tune is playing or paused, hold down the **REW** button to skip in a reverse direction at high speed.
 - The fast reverse operation skips back one measure at a time.
 - The measure and beat numbers on the display change while the fast reverse operation is being performed.



2. Releasing the **REW** button starts song playback from the measure whose number is shown on the display.

NOTE

Fast reverse does not work while Song Bank play is stopped.

To fast forward

1. While a tune is playing or paused, hold down the **FF** button to skip forward at high speed.
 - The fast forward operation skips forward one measure at a time.
 - The measure and beat numbers on the display change while the fast forward operation is being performed



2. Releasing the **FF** button starts song playback from the measure whose number is shown on the display.

NOTE

Fast forward does not work while Song Bank play is stopped.

To change the melody tone

1. While a tune is playing or paused, press the **TONE** button.



2. Find the tone you want in the **TONE List**, and then use the **number** buttons to input its three-digit number.

Example: To select "040 VIOLIN", input 0, then 4, then 0.

- You can select any one of the keyboard's 137 built-in tones.



NOTES

- You can also use the [+] and [-] buttons to change the melody tones.
- For two-hand tunes (Etude and Concert Piece tunes), the same tone is applied for both the left and right hand parts.
- Specifying the tune number for the same tune that is currently selected returns the melody tone to the default setting for that tune.

To play all tunes in succession

1. Press the **DEMO** button.
 - Playback starts from Song Bank tune number 00, followed in sequence by Etude, and then Concert Piece tunes.
2. To stop Song Bank tune play, press the **DEMO**, **STOP**, or **START/STOP** button.

NOTES

- While a tune is playing, you can use the number buttons or [+] and [-] to change to another tune.
- You can play along with the tunes on the keyboard.
- Pressing the SONG BANK, ETUDE or CONCERT PIECE button what playback is in progress jumps to tune number 00 of the corresponding group.

3-Step Lesson

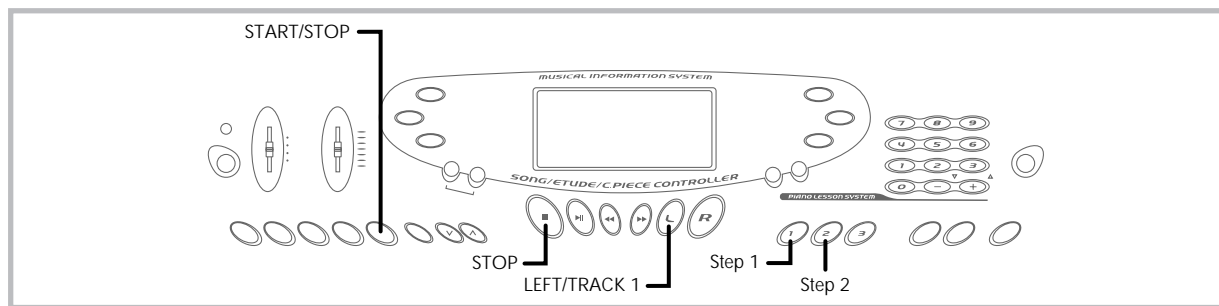

The 3-step lesson feature takes you through the three distinct steps described below to help you learn to play tunes on the keyboard.

Step 1 – Master the timing.

In this step, pressing any key on the keyboard plays the correct note, so you can concentrate on getting the timing right without worrying about playing the right note. The sub-melody (obligato) waits until you press a key before proceeding to the next phrase.

Step 2 – Master the melody.

In this step, you learn the keys to press to play the melody. The keys you need to press light on the on-screen keyboard guide, so simply follow along as you learn to play. The sub-melody (obligato) waits until you play the correct note, so you can learn at your own pace.

Step 3 – Play a normal speed.

This is where you enjoy actually playing the tunes you learn using Step 1 and Step 2. The on-screen keyboard guide still shows you which keyboard keys to press, but accompaniment proceeds at normal speed regardless of whether or not you play the correct notes.

Tune Types and Their Parts

The built-in tunes of this keyboard are divided between two basic groups: Auto Accompaniment tunes (Song Bank) and two-hand accompaniment tunes (Etude and Concert Piece). The parts available for 3-step lesson practice depend on the type of tune you are using.

Auto Accompaniment Tunes (Song Bank)

As their name suggests, these tunes are made up of an Auto Accompaniment part and a melody part. When using these tunes for a 3-step lesson, you can practice playing along with the melody (right hand) part only.

Two-hand Tunes (Etude, Concert Piece)

These types of tunes are played with both hands, as in a piano solo. When using these tunes for a 3-step lesson, you can practice playing along with both the left hand and right hand parts.

Display Contents During 3-step Lesson Play

Whenever you select an Auto Accompaniment tune for 3-step lesson play, the on-screen keyboard guide and staff notation shows the note you should play and its length. The on-screen keyboard guide also shows the notes you play on the keyboard. The following describes the information that appears on the display.

Note Pitch

The key you should press lights on the on-screen keyboard guide, while the actual pitch of the note appears in the display's staff notation area. The fingers you should use to play the notes are also shown on the display.

Note Length

The key stays lit on the on-screen keyboard guide for as long as the note should be sustained. The staff notation and fingerings also remain on the display for the length of the note.

Next Note

An on-screen keyboard guide key flashes to indicate the next note to be played, while a number appears on the display near the finger you should use to play the next note.

Series of Same Pitch Notes

The on-screen keyboard guide key turns off momentarily between the notes, and lights again for each successive note. The staff notation and fingerings also turn off and back on again.

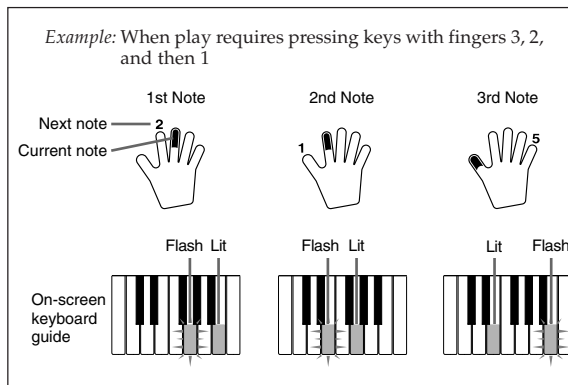

NOTES

- Note length is not indicated when you are using two-hand tunes with 3-step lesson Steps 1 and 2. As soon as you press a key that is lit on the on-screen keyboard guide, it goes out and the next key you need to press starts to flash.
- Note length is indicated by the on-screen keyboard guide when you use two-hand tunes with Step 3. In this case, the next key to be pressed does not flash when you press a lit key and the next finger number does not appear on the display. Only the current finger number is shown.

3-step Lesson Tempo Setting

Use the procedure under "Adjusting the Tempo" on page E-16 to adjust the tempo for 3-step lesson play.

Step 1 – Master the timing.

1. Select the tune you want to use.
2. Press the **step 1 button** to start Step 1 play.
 - After a count sounds, the keyboard stands by and waits for you to play the first note of the tune.

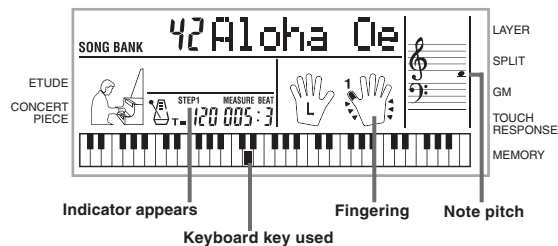

- The hand you should use is indicated by arrows around it.

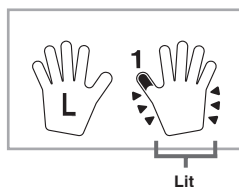

3. Press any keyboard keys to play the melody (right hand part).

- The key for the next note to be played flashes on the on-screen keyboard guide and the keyboard waits for you to play it. When you press any key to play the note, the on-screen key remains lit as the note plays.
- Accompaniment (left-hand part) waits until you press any key to play a note.
- If you accidentally press more than one key in succession, accompaniment is played for the corresponding number of notes.
- Pressing more than one key at the same time counts as a single melody note. Pressing a key while another key is held down is counted as two melody notes.

4. To stop play at any time, press the **STOP** or **START/STOP** button.

■ NOTES ■

- Left hand practice can also be performed with two-hand tunes. Simply select one of the two-hand tunes in step 1 of the above procedure, and then press the LEFT/TRACK 1 button following step 2.
- 3-step lesson does not allow simultaneous practice of both hands.
- You can also use fast forward and fast reverse operations with Step 1 play.
- You cannot pause Step 1 play.
- Rhythm does not sound during Step 1 play.

Step 2 – Master the melody.

1. Select the tune you want to use.
2. Press the **step 2 button** to start Step 2 play.
 - After a count sounds, the keyboard stands by and waits for you to play the first note of the tune.

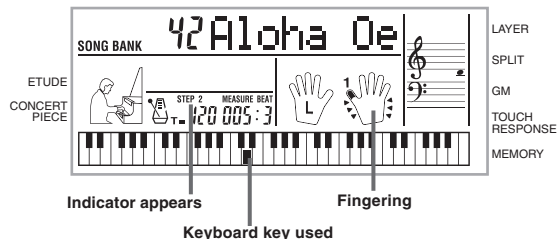

3. Play the melody (right hand part) as indicated by the on-screen keyboard guide.

- The key for the next note to be played flashes on the on-screen keyboard guide and the keyboard waits for you to play it. When you press any key to play the note, the on-screen key remains lit as the note plays.
- If multiple keys light on the on-screen keyboard guide when you are using a two-hand tune, it means that you must press all of the keys that are lit.

4. To stop play at any time, press the **STOP** or **START/STOP** button.

■ NOTES ■

- Left hand practice can also be performed with two-hand tunes. Simply select one of the two-hand tunes in step 1 of the above procedure, and then press the LEFT/TRACK 1 button following Step 2.
- 3-step lesson does not allow simultaneous practice of both hands.
- You can also use fast forward and fast reverse operations with Step 2 play.
- You cannot pause Step 2 play.
- Rhythm does not sound during Step 2 play.

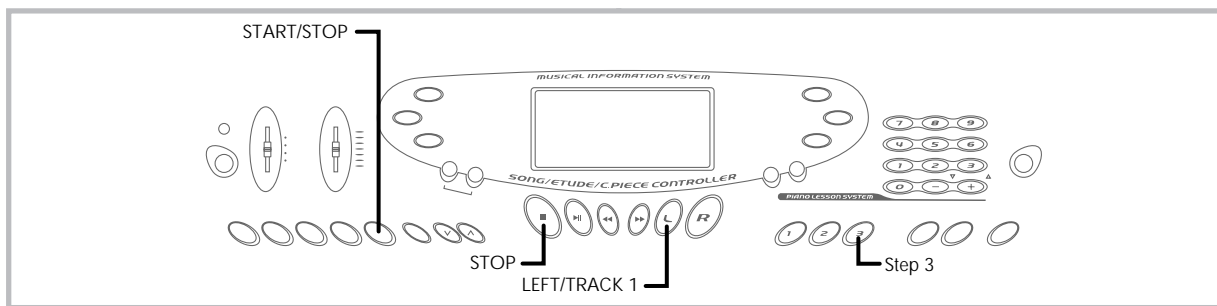

Step 3 – Play a normal speed.

1. Select the tune you want to play.
2. Press the **step 3 button** to start Step 3 play.
 - Accompaniment (left hand part) starts to play at normal speed.

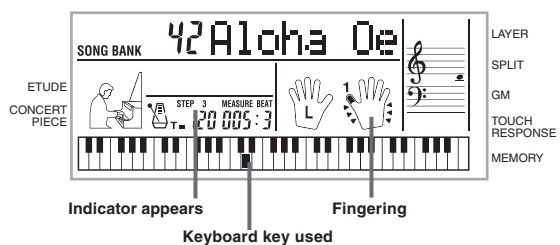

3. Play the melody (right hand part) as indicated by the on-screen keyboard guide.
4. To stop play at any time, press the **STOP** or **START/STOP** button.

NOTES

- Left hand practice can also be performed with two-hand tunes. Simply select one of the two-hand tunes in step 1 of the above procedure, and then press the **LEFT/TRACK 1** button following step 2.
- 3-step lesson does not allow simultaneous practice of both hands.
- You can also use pause, fast forward and fast reverse operations with Step 3 play.

Memory Function

You can store up to two separate songs in memory for later playback. The memory function records your keyboard play in real time, as you play it.

Tracks

The memory of this keyboard records and plays back notes much like a standard tape recorder. There are two tracks, each of which can be recorded separately. Besides notes, each track can be assigned its own tone number. During playback you can adjust the tempo to change the speed of playback.

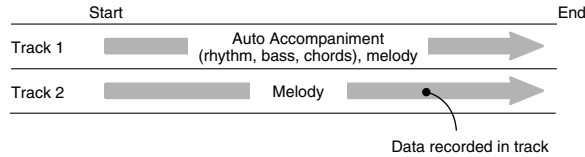

NOTES

- Track 1 is the basic track, which can be used to record Auto Accompaniment along with the melody. Track 2 can be used for melody only, and is for adding to what is recorded in Track 1.
- Note that each track is independent of the other. This means that if you make a mistake while recording, you need to re-record only the track where the mistake was made.

Memory Button Operation

Each press of the MEMORY button cycles through the functions shown below.

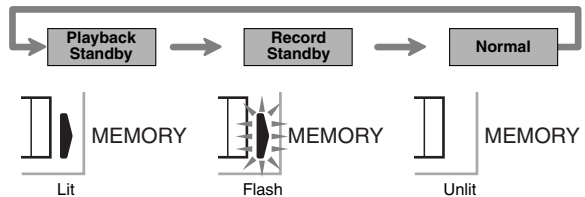

Selecting a Track

Press the LEFT/TRACK 1 button to select Track 1 and the RIGHT/TRACK 2 button to select Track 2. The letter "L" (left) appears on the display to indicate Track 1 is selected, and the letter "R" (right) appears to indicate Track 2 is selected.

Playback

Each press of the LEFT/TRACK 1 and RIGHT/TRACK 2 button while the keyboard is in playback standby (see "Memory Button Operation" above) toggles playback of the corresponding track on and off. The letter that identifies a track (L or R) appears on the display whenever playback of that track is turned on.

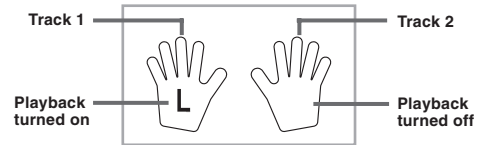

- With the above setting, Track 1 will play while Track 2 will not play.

Record

Each press of the LEFT/TRACK 1 and RIGHT/TRACK 2 button while the keyboard is in record standby (see "Memory Button Operation") toggles recording to the corresponding track on and off. The letter that identifies a track (L or R) flashes on the display whenever recording to that track is turned on.



- The above indicates that Track 1 will play back while Track 2 is being recorded to.

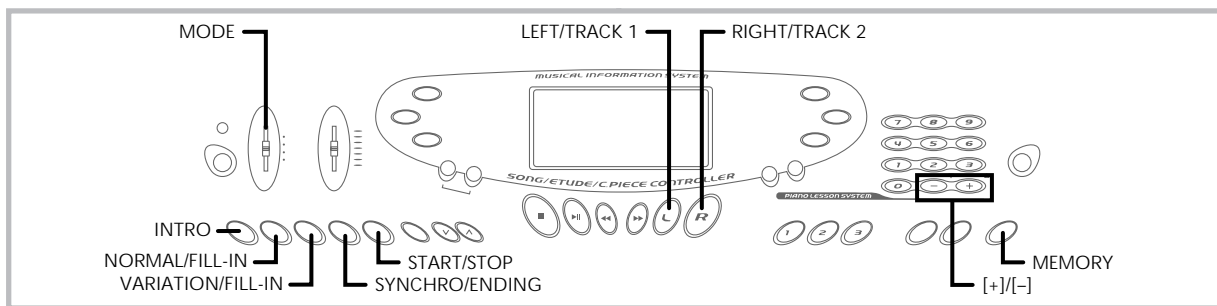

Real-time Recording to Track 1

With real-time recording, the notes and chords you play on the keyboard are recorded as you play them.

To record to Track 1 using real-time recording

1. Use the **MEMORY** button to enter record standby.

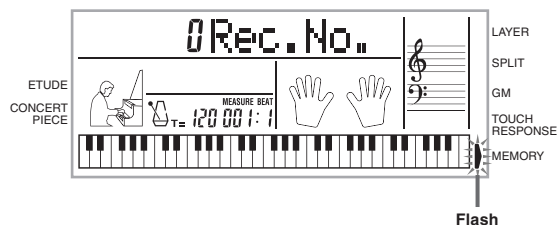

2. Use **[+]** and **[-]** to select 0 or 1 as the song number.
 - The track is not yet selected at this point.
 - The above song number screen remains on the display for about five seconds. If it disappears before you have a chance to select a song number, use the **MEMORY** button to display it again.

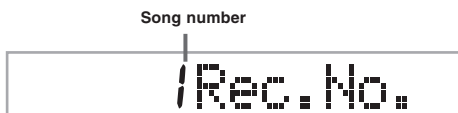

3. Press the **LEFT/TRACK 1** button to select Track 1.
 - The "L" flashes on the display to indicate the track that will be recorded to.

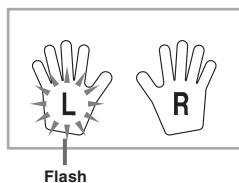

4. Make any of the following settings if you want.
 - Tone number (page E-14)
 - Rhythm number (page E-16)
 - **MODE** switch (page E-17)
 - If you are not confident about playing at a fast tempo, try using a slower tempo setting (page E-16).

5. Press the **START/STOP** button to start real-time recording to Track 1.
6. Play something on the keyboard.
 - Any melody and accompaniment you play on the keyboard (including Auto Accompaniment chords played on the accompaniment keyboard) is recorded.
 - If you use a pedal during recording, pedal operations are also recorded.
7. Press the **START/STOP** button to end recording when you are finished playing.

- If you make a mistake while recording, stop the record operation and begin over again from step 1.

NOTE

Using real-time recording to record to a track that already contains recorded data replaces the existing recording with the new one.

Track 1 Contents After Real-time Recording

In addition to keyboard notes and accompaniment chords, the following data is also recorded to Track 1 during real-time recording. This data is used whenever Track 1 is played back.

- Tone number
- Rhythm number
- **INTRO**, **SYNCHRO/ENDING**, **NORMAL/FILL-IN**, **VARIATION/FILL-IN** button operations
- Pedal operations

Memory Capacity

The keyboard has memory for approximately 5,200 notes. You can use all 5,200 notes for a single song, or you can divide memory between two different songs.

- The measure number and note number flash on the display whenever remaining memory is less than 100 notes.



- Recording automatically stops (and Auto Accompaniment and rhythm stops playing if they are being used) whenever memory becomes full.

Memory Data Storage

- Anything previously stored in memory is replaced whenever you make a new recording.
- Memory contents are retained as long as the keyboard is supplied with electrical power. Unplugging the AC adaptor when batteries are not loaded or when loaded batteries are dead cuts off the keyboard's electrical power supply, causing all data stored in memory to be deleted. Be sure to plug the keyboard into an electrical outlet with the AC adaptor before replacing batteries.
- Turning off the keyboard while a record operation is in progress causes the contents of the track you are currently recording to be lost.

Track 1 Real-time Recording Variations

The following describes a number of different variations you can use when recording to Track 1 using real-time recording. All of these variations are based upon the procedure described under "To record to Track 1 using real-time recording" on page E-28.

To record without rhythm

Skip step 5. Real-time recording without rhythm starts when you press a keyboard key.

To start recording with synchro start

In place of step 5, press the SYNCHRO/ENDING button. Auto Accompaniment and recording will both start when you play a chord on the accompaniment keyboard.

To record using an intro, ending, or fill-in

During recording, the INTRO, SYNCHRO/ENDING, NORMAL/FILL-IN, and VARIATION/FILL-IN buttons (pages E-19 through E-20) can all be used as they normally are.

To synchro start Auto Accompaniment with an intro pattern

In place of step 5, press the SYNCHRO/ENDING button and then the INTRO button. Auto Accompaniment will start with the intro pattern when you play a chord on the accompaniment keyboard.

To start Auto Accompaniment part way into a recording

In place of step 5, press the SYNCHRO/ENDING button and then play something on the melody keyboard to start. When you reach the point where you want Auto Accompaniment to start, play a chord on the accompaniment keyboard.

Playing Back from Memory

Use the following procedure to play back memory contents.

To play back from memory

1. Use the MEMORY button to enter playback standby, and then use [+] and [-] to select 0 or 1 as the song number.
 - The above song number screen remains on the display for about five seconds. If it disappears before you have a chance to select a song number, use the MEMORY button to display it again.



2. Press the START/STOP button to start playback of the song you selected.
 - During memory playback you can use the LEFT/TRACK 1 and RIGHT/TRACK 2 buttons to turn playback of either track on or off.

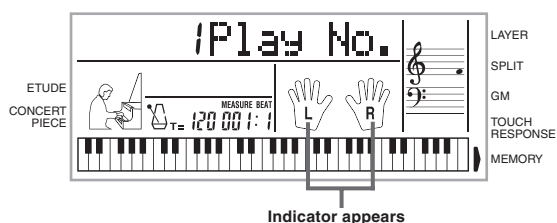

- You can use the TEMPO buttons to adjust the tempo.

3. Press the START/STOP button again to stop playback.

■ NOTES ■

- During memory playback, the entire keyboard functions as a melody keyboard, regardless of the MODE switch setting.
- You can play along on the keyboard while playing back from memory. You can also use layer (page E-32) and split (page E-32) to play along with more than one tone.
- You cannot use pause, fast forward or fast reverse operations with memory playback.

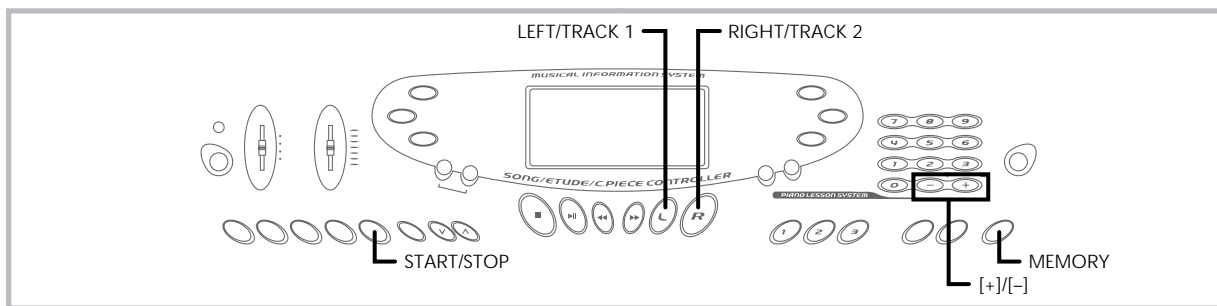

Real-time Recording to Track 2

After you record Track 1, you can use real-time recording to add a melody in Track 2.

To record to Track 2 while playing back Track 1

1. Use the **MEMORY** button to enter record standby, and then use **[+]** and **[-]** to select 0 or 1 as the song number.
 - The song number you select should be the one where you previously input Track 1.



- The track is not yet selected at this point.
2. Press the **RIGHT/TRACK 2** button to select Track 2.

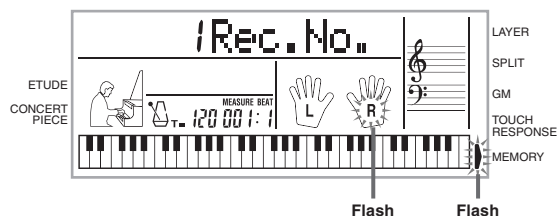

3. Make any of the following settings if you want.
 - Tone number (page E-14)
 - If you are not confident about playing at a fast tempo, try using a slower tempo setting (page E-16).
4. Press the **START/STOP** button to start real-time recording to Track 2 along with playback from Track 1.
5. Listening to the playback from Track 1, play what you want to record to Track 2 on the keyboard.
6. Press the **START/STOP** button to end recording when you are finished playing.
 - If you make a mistake while recording, stop the record operation and begin over again from step 1.

NOTE

Track 2 is a melody-only track, so chords cannot be recorded there. Because of this, the entire keyboard is a melody keyboard, regardless of the MODE switch setting.

To record to Track 2 without playing back Track 1

1. Use the **MEMORY** button to enter record standby.
2. Press the **LEFT/TRACK 1** button to turn off playback of Track 1.
3. Continue from step 1 under "To record to Track 2 while placing back Track 1."
 - Note that the above procedure does not turn off rhythm and Auto Accompaniment.

Track 2 Contents After Real-time Recording

The following data is recorded to Track 2 during real-time recording.

- Tone number
- Pedal operations

Deleting the Contents of a Specific Track

Use the following procedure to delete all of the data currently recorded in a specific track.

To delete all of the data in a specific track

1. Use the **MEMORY** button to enter record standby, and then use **[+]** and **[-]** to select the song (0 or 1) whose track you want to delete.



2. Hold down the **MEMORY** button until the track delete screen appears on the display.



3. Use the **LEFT/TRACK 1** or **RIGHT/TRACK 2** button to select the track whose data you want to delete.
Example: To select Track 1

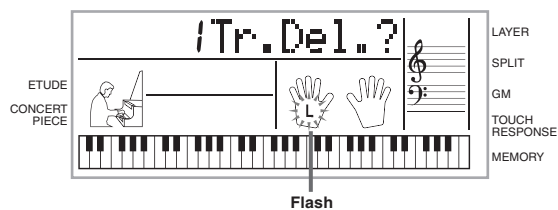

4. Press the **[+]** button.
 - This deletes the selected track and enters memory playback standby.

NOTES

- The track delete screen is cleared from the display automatically if you leave the keyboard with the track delete message on the display for about five seconds without doing anything.
- Once you select a track in step 3, you cannot change to a different track without quitting the track delete operation and starting again.
- You cannot select a track for deletion if that track does not contain any data.
- Pressing the **MEMORY** button while the track delete screen is on the display returns to record standby.

Keyboard Settings

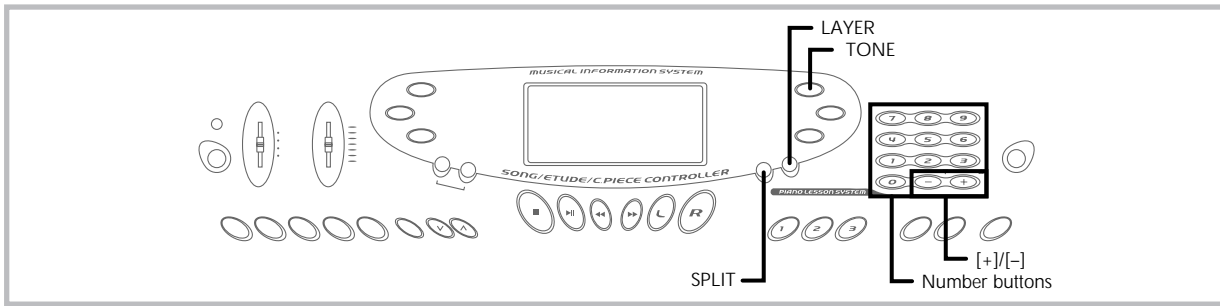

This section describes how to use layer (to play two tones with a single key) and split (to assign different tones to either end of the keyboard), and how to make touch response, transpose, and tuning settings.

Using Layer

Layer lets you assign two different tones (a main tone and a layered tone) to the keyboard, both of which play whenever you press a key. For example, you could layer the FRENCH HORN tone on the BRASS tone to produce a rich and brassy sound.

To layer tones

1. First select the main tone.
Example: To select "061 BRASS" as the main tone, press the TONE button and then use the number buttons or [+] and [-] buttons to input 0, 6 and then 1.



2. Press the LAYER button.

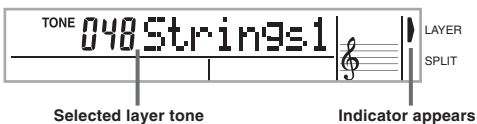

3. Select the layered tone.
Example: To select "060 FRENCH HORN" as the layered tone, use the number buttons or [+] and [-] buttons to input 0, 6 and then 0.



4. Now try playing something on the keyboard.
 - Both tones are played at the same time.
5. Press the LAYER button again to unlayer the tones and return the keyboard to normal.

LAYER

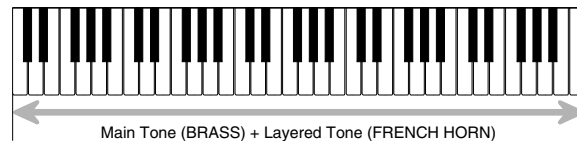

Using Split

With split you can assign two different tones (a main tone and a split tone) to either end of the keyboard, which lets you play one tone with your left hand and another tone with your right hand. For example, you could select STRINGS as the main (high range) tone and PIZZICATO as the split (low range) tone, putting an entire string ensemble at your fingertips. Split also lets you specify the split point, which is the location on the keyboard where the changeover between the two tones occurs.

To split the keyboard

1. First select the main tone.
Example: To select "048 STRINGS 1" as the main tone, press the TONE button and then use the number buttons or [+] and [-] buttons to input 0, 4 and then 8.



2. Press the SPLIT button.



3. Select the split tone.
Example: To select "045 PIZZICATO STR" as the split tone, use the number buttons or [+] and [-] buttons to input 0, 4 and then 5.



- Specify the split point. While holding down the **SPLIT** button, press the keyboard where you want the leftmost key of the high end range to be.

Example: To specify G3 as the split point, press the G3 key.



- Now try playing something on the keyboard.
 - Every key from F³ and below is assigned the PIZZICATO tone, while every key from G3 and above is assigned the STRINGS tone.
- Press the **SPLIT** button again to unsplit the keyboard and return it to normal.

SPLIT

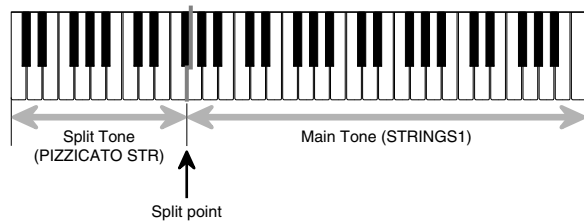

Using Layer and Split Together

You can use layer and split together to create a layered split keyboard. It makes no difference whether you layer tones first and then split the keyboard, or split the keyboard and then layer tones. When you use layer and split in combination, the high range of the keyboard is assigned two tones (main tone + layered tone), and the low range two tones (split tone + layered split tone).

To split the keyboard and then layer tones

- Press the **TONE** button and then input the tone number of the main tone.



- Press the **SPLIT** button and then input the number of the split tone.

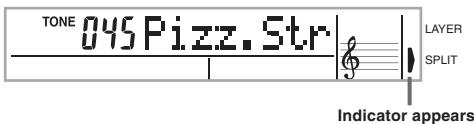

- After specifying the split tone, press the **SPLIT** button to unsplit the keyboard.

- Press the **LAYER** button and then input the number of the layered tone.
 - Note that you can reverse steps 2 and 3, specifying the layered tone first and then the split tone.



- Press the **SPLIT** button or the **LAYER** button so both of the **SPLIT** and **LAYER** indicators are displayed.

- Input the number of the layered split tone.



- Specify the split point.
 - While holding down the **SPLIT** button, press the keyboard where you want the leftmost key of the low end range to be.

- Play something on the keyboard.
 - Press the **LAYER** button to unlayer the keyboard, and the **SPLIT** button to unsplit it.

LAYER SPLIT

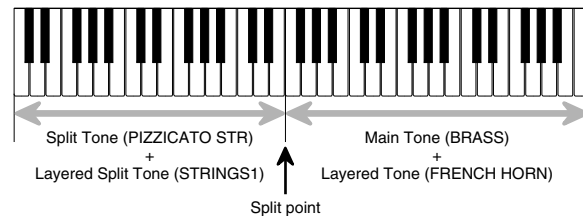

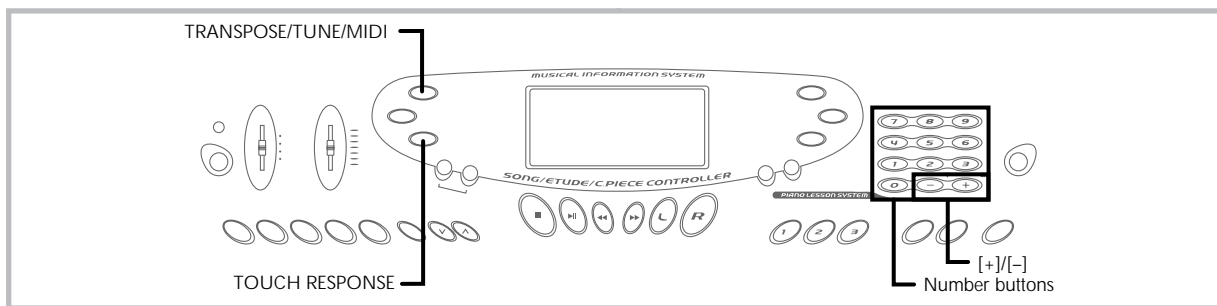

Using Touch Response

When touch response is turned on, the relative volume of sound output by the keyboard is varied in accordance with the amount of pressure applied, just like an acoustic piano.

To turn touch response on and off

Press the **TOUCH RESPONSE** button to toggle touch response on and off.

- Touch response is on when touch response indicator is on.

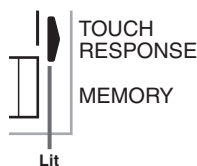

- Touch response is off when touch response indicator is off.



NOTES

- You can adjust touch response sensitivity using the procedure under "TOUCH CURVE" on page E-39.
- Touch response not only affects the keyboard's internal sound source, it also is output as MIDI data.
- Memory playback, accompaniment, and external MIDI note data does not affect the touch response setting.

Transposing the Keyboard

Transpose lets you raise and lower the overall key of the keyboard in semitone units. If you want to play an accompaniment for a vocalist who sings in a key that's different from the keyboard, for example, simply use transpose to change the key of the keyboard.

To transpose the keyboard

1. Press the **TRANSPOSE/TUNE/MIDI** button until the transpose screen appears on the display.



2. Use the **[+]**, **[-]**, and the **number buttons** to change the transpose setting of the keyboard.

Example: To transpose the keyboard five semitones upwards.



NOTES

- The keyboard can be transposed within a range of -12 (one octave downwards) to +12 (one octave upwards).
- The default transpose setting is "00" when keyboard power is turned on.
- If you leave the transpose screen on the display for about five seconds without doing anything, the screen is automatically cleared.
- The transpose setting also affects playback from memory and Auto Accompaniment.

TRANSPOSE/TUNE/MIDI Button

Each press of the TRANSPOSE/TUNE/MIDI button cycles through a total of 12 setting screens: the transpose screen, the tuning screen, and 10 MIDI setting screens (page E-36). If you accidentally pass the screen you want to use, keep pressing the TRANSPOSE/TUNE/MIDI button until the screen appears again.

Tuning the Keyboard

Use the following procedure to fine tune the keyboard to match the tuning of another musical instrument.

To tune the keyboard

1. Press the **TRANPOSE/TUNE/MIDI** button twice to display the tuning screen.



00 Tune

2. Use the **[+]**, **[-]**, and the **number** buttons to adjust the tuning value.

Example: To lower tuning by 20



-20 Tune

! NOTES !

- The keyboard can be tuned within a range of -50 cents to +50 cents.
*100 cents is equivalent to one semitone.
- The default tuning setting is "00" when keyboard power is turned on.
- If you leave the tuning screen on the display for about five seconds without doing anything, the screen is automatically cleared.
- The tuning setting also affects playback from memory and Auto Accompaniment.

MIDI

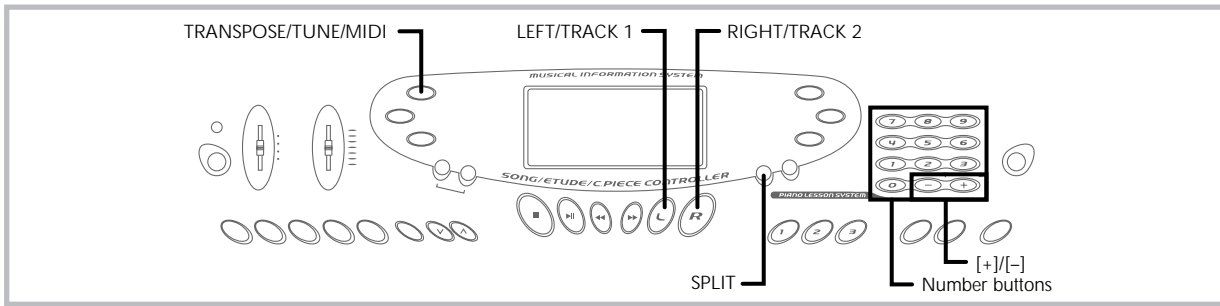

What is MIDI?

The letters MIDI stand for Musical Instrument Digital Interface, which is the name of a worldwide standard for digital signals and connectors that makes it possible to exchange musical data between musical instruments and computers (machines) produced by different manufacturers. MIDI compatible equipment can exchange keyboard key press, key release, tone change, and other data as messages. Though you do not need any special knowledge about MIDI to use this keyboard as a stand-alone unit, MIDI operations require a bit of specialized knowledge. This section provides you with an overview of MIDI that will help to get you going.

MIDI Connections

MIDI messages are sent out through the MIDI OUT terminal of one machine to the MIDI IN terminal of another machine over a MIDI cable. To send a message from this keyboard to another machine, for example, you must use a MIDI cable to connect the MIDI OUT terminal of this keyboard to the MIDI IN terminal of the other machine. To send MIDI messages back to this keyboard, you need to use a MIDI cable to connect the other machine's MIDI OUT terminal to the MIDI IN terminal of this keyboard. To use a computer or other MIDI device to record and playback the MIDI data produced by this keyboard, you must connect the MIDI IN and MIDI OUT terminals of both machines in order to send and receive data.

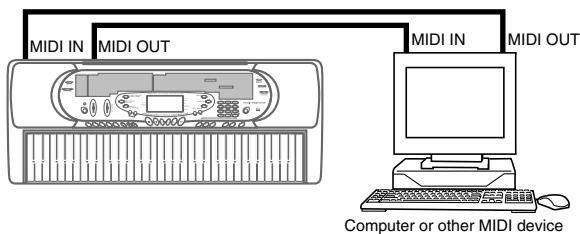

- To use the MIDI THRU function of a connected computer, sequencer, or other MIDI device, be sure to turn this keyboard's LOCAL CONTROL off (page E-38).

MIDI Channels

MIDI allows you to send the data for multiple parts at the same time, with each part being sent over a separate MIDI channel. There are 16 MIDI channels, numbered 1 through 16, and MIDI channel data is always included whenever you exchange data (key press, pedal operation, etc.) Both the sending machine and the receiving machine must be set to the same channel for the receiving unit to correctly receive and play data. If the receiving machine is set to Channel 2, for example, it receives only MIDI Channel 2 data, and all other channels are ignored.

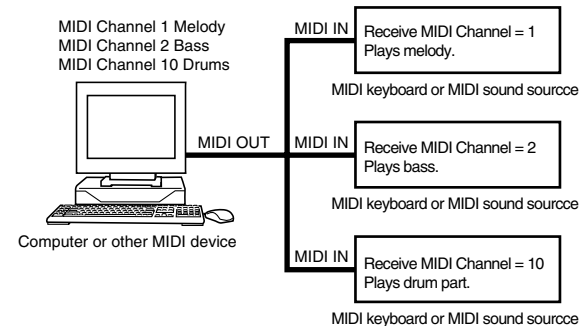

This keyboard is equipped with multi-timbre capabilities, which means it can receive messages over all 16 MIDI channels and play up to 16 parts at the same time. Keyboard and pedal operations performed on this keyboard are sent out by selecting a MIDI channel (1 to 16) and then sending the appropriate message.

General MIDI

As we have already seen, MIDI makes it possible to exchange musical data between devices produced by different manufacturers. This musical data does not consist of the notes themselves, but rather information on whether a keyboard key is pressed or released, and the tone number.

If tone number 1 on a keyboard produced by Company A is PIANO while tone number 1 on a Company B's keyboard is BASS, for example, sending data from Company A's keyboard to Company B's keyboard produces a result entirely different from the original. If a computer, sequencer or other device with auto accompaniment capabilities is used to produce music data for the Company A keyboard which has 16 parts (16 channels) and then that data is sent to the Company B keyboard which can receive only 10 parts (10 channels), the parts that cannot be played will not be heard.

The standard for the tone numbering sequence, the number of pads, and other general factors that determine the sound source configuration, which was arrived at by mutual consultations by manufacturers, is called General MIDI.

The General MIDI standard defines the tone numbering sequence, the drum sound numbering sequence, the number of MIDI channels that can be used, and other general factors that determine the sound source configuration. Because of this, musical data produced on a General MIDI sound source can be played back using similar tones and identical nuances as the original, even when played on another manufacturer's sound source.

This keyboard conforms with General MIDI standards, so it can be connected to a computer or other device and used to play back General MIDI data that has been purchased, downloaded from the Internet, or obtained from any other source.

Changing MIDI Settings

You can use this keyboard in combination with an external sequencer, synthesizer, or other MIDI device to play along with commercially available General MIDI software. This section tells you how to make the MIDI settings required when connecting to an external device.

TRANSPOSE/TUNE/MIDI Button

Each press of the TRANSPOSE/TUNE/MIDI button cycles through a total of 12 setting screens: the transpose screen, the tuning screen, and 10 MIDI setting screens. If you accidentally pass the screen you want to use, keep pressing the TRANSPOSE/TUNE/MIDI button until the screen appears again. Also note that leaving a setting screen is automatically cleared from the display if you do not perform any operation for about five seconds.

GM MODE (Default: Off)

on: This keyboard plays General MIDI data from a computer or other external device. MIDI IN CHORD JUDGE cannot be used when GM MODE is turned on.

off: MIDI IN CHORD JUDGE can be used.

1. Press the **TRANSPOSE/TUNE/MIDI button** until the GM MODE screen appears.

Example: When GM MODE is turned off

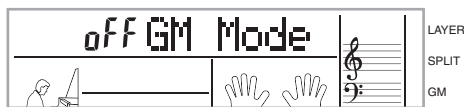

2. Use the **[+]** and **[-]** or **[0]** and **[1]** buttons to turn the setting on and off.

Example: To turn GM MODE on

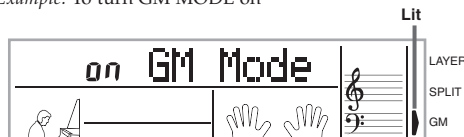

KEYBOARD CHANNEL

The keyboard channel is the channel used to send MIDI messages from this keyboard to an external device. You can specify one channel from 1 to 16 as the keyboard channel.

1. Press the **TRANSPOSE/TUNE/MIDI button** until the KEYBOARD CHANNEL screen appears.



2. Use the **[+]**, **[-]**, and the **number buttons** to change the channel number.

Example: To specify channel 4



NAVIGATE CHANNEL (Default: 4)

When MIDI messages are received from an external device for play on this keyboard, the navigate channel is the channel whose note data appears on the display. You can select one channel from 1 to 8 as the navigate channel. Since this setting lets you use the data on any channel of commercially available MIDI software to light on the on-screen keyboard guide, you can analyze how different parts of an arrangement are played.

1. Press the **TRANSPOSE/TUNE/MIDI button** until the NAVIGATE CHANNEL screen appears.



2. Use the **[+]**, **[-]**, and the **number buttons [1] through [8]** to change the channel number.

Example: To specify channel 2



NOTE

The navigate channel automatically changes to 1 whenever you turn MIDI IN CHORD JUDGE.

To turn off specific sounds before playing back MIDI data that is being received

<<Navigate channel on/off>>

While playing MIDI data, press the **RIGHT/TRACK 2 button**.

- This cuts the sound of the navigate channel, but on-screen keyboard guide keys continue to light in accordance with the channel's data as it is received. Press RIGHT/TRACK 2 button again to turn the channel back on.

<<Next lower channel from navigate channel on/off>>

While playing MIDI data, press the **LEFT/TRACK 1 button**.

- This cuts the sound of the channel whose number is one less than the navigate channel, but on-screen keyboard guide keys continue to light in accordance with the channel's data as it is received. Press LEFT/TRACK 1 button again to turn the channel back on.

Example: If the navigate channel is channel 4, the above operation turns off channel 3. If the navigate channel is channel 1 or 2, the above operation turns off channel 8.

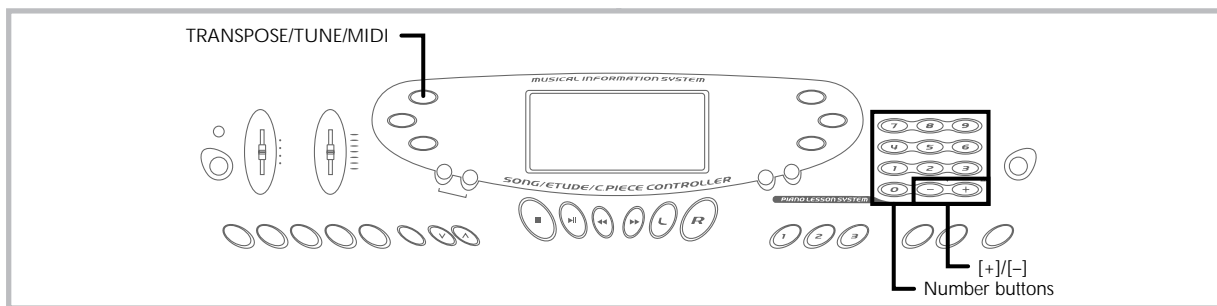

MIDI IN CHORD JUDGE (Default: Off)

on: When a chord specification method is selected by the MODE switch, chords are specified by the keyboard channel note data input from the MIDI IN terminal.

off: MIDI IN CHORD JUDGE is turned off.

1. Press the **TRANSPOSE/TUNE/MIDI** button until the MIDI IN CHORD JUDGE screen appears.



2. Use the **[+]** and **[-]** or **[0]** and **[1]** buttons to turn the setting on and off.

Example: To turn MIDI IN CHORD JUDGE on



NOTE

MIDI IN CHORD JUDGE automatically turns off whenever you change the navigate channel to any channel besides 01.

LOCAL CONTROL (Default: On)

This setting determines whether or not the keyboard and sound source of this keyboard are connected internally. When recording to a computer or other external device connected to this keyboard's MIDI IN/OUT terminal, it helps if you turn LOCAL CONTROL off.

on: Anything played on the keyboard is sounded by the internal sound source and simultaneously output as a MIDI message from the MIDI OUT terminal.

off: Anything played on the keyboard is output as a MIDI message from the MIDI OUT terminal, without being sounded by the internal sound source. Turn LOCAL CONTROL off whenever you are using the MIDI THRU function of a computer or other external device. Also note that the no sound is produced by the keyboard if LOCAL CONTROL is turned off and no external device is connected.

1. Press the **TRANSPOSE/TUNE/MIDI** button until the LOCAL CONTROL screen appears.

Example: When LOCAL CONTROL is on



2. Use the **[+]** and **[-]** or **[0]** and **[1]** buttons to turn the setting on and off.

Example: To turn LOCAL CONTROL off

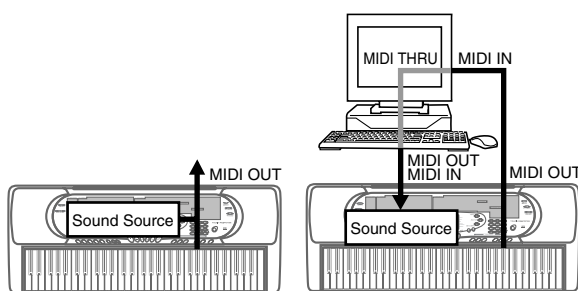

LOCAL CONTROL On

Notes played on the keyboard are sounded by the internal sound source and output as MIDI messages from the MIDI OUT terminal.

LOCAL CONTROL Off

Notes played on the keyboard are output as MIDI messages from the MIDI OUT terminal, but not sounded directly by the internal sound source. The MIDI THRU terminal of the connected device can be used to return the MIDI message and sound it on this keyboard's sound source.

ACCOMP MIDI OUT (Default: Off)

on: Auto Accompaniment is played by the keyboard and the corresponding MIDI message is output from the MIDI OUT terminal.

off: Auto Accompaniment MIDI messages are not output from the MIDI OUT terminal.

1. Press the **TRANSPOSE/TUNE/MIDI** button until the ACCOMP MIDI OUT screen appears.

Example: When ACCOMP MIDI OUT is off



2. Use the **[+]** and **[-]** or **[0]** and **[1]** buttons to turn the setting on and off.

Example: To turn ACCOMP MIDI OUT on



TOUCH CURVE (Default: 0)

0: Normal touch curve

1: Louder than normal tone, even when little pressure is used to press keyboard keys. When touch response is turned off, sound is produced at a louder volume than normal.

1. Press the **TRANPOSE/TUNE/MIDI** button until the TOUCH CURVE SELECT screen appears.



2. Use the **[+]** and **[-]** or **[0]** and **[1]** buttons to change the setting.

Example: To select touch curve 1



ASSIGNABLE JACK

SUS(sustain): Specifies a sustain*1 effect when the pedal is depressed.

SoS (sostenuto): Specifies a sostenuto*2 effect when the pedal is depressed.

SFt (soft): Specifies reduction of the sound's volume when the pedal is depressed.

rHy (rhythm): Specifies START/STOP button operation when the pedal is depressed.

1. Press the **TRANPOSE/TUNE/MIDI** button until the ASSIGNABLE JACK screen appears.

Example: When sustain is currently set



2. Use the **[+]** and **[-]** or **[0]**, **[1]**, **[2]**, and **[3]** buttons to change the setting.

Example: To select rhythm



*1 Sustain

With piano tones and other sounds that decay, the pedal acts as a damper pedal, with sounds being sustained longer when the pedal is depressed. With organ tones and other continuous sounds, notes played on the keyboard continue to sound until the pedal is released. In either case, the sustain effect is also applied to any notes that are played while the pedal is depressed.

*2 Sostenuto

This effect performs the same way as sustain, except that it is applied only to notes that are sounding already when the pedal is depressed. It does not affect notes that are played after the pedal is depressed.

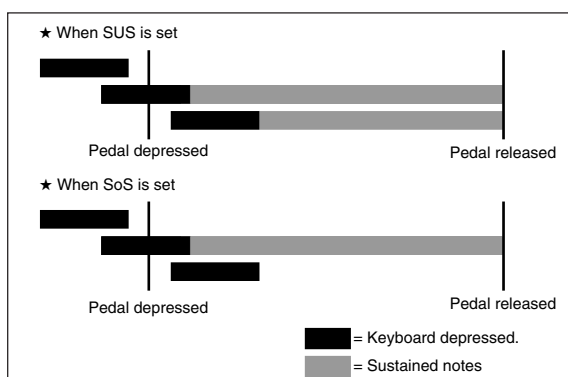

SOUND RANGE SHIFT (Default: On)

on: Shifts low range tones one octave lower and 072 PICCOLO one octave higher.

oFF: Plays low range tones and 072 PICCOLO at their normal levels.

1. Press the **TRANPOSE/TUNE/MIDI** button until the SOUND RANGE SHIFT screen appears.



2. Use the **[+]** and **[-]** or **[0]** and **[1]** buttons to change the setting.

Example: To turn SOUND RANGE SHIFT off



Messages

There is a wide variety of messages defined under the MIDI standard, and this section details the particular messages that can be sent and received by this keyboard. An asterisk is used to mark messages that affect the entire keyboard. Messages without an asterisk are those that affect only a particular channel.

NOTE ON/OFF

This message sends data when a key is pressed (NOTE ON) or released (NOTE OFF).

A NOTE ON/OFF message include a note number (to indicate note whose key is being pressed or released) and velocity (keyboard pressure as a value from 1 to 127). NOTE ON velocity is always used to determine the relative volume of the note. This keyboard does not receive NOTE OFF velocity data.

Whenever you press or release a key on this keyboard, the corresponding NOTE ON or NOTE OFF message is sent from the MIDI OUT terminal.

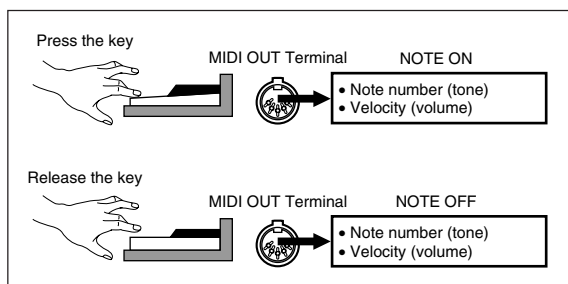

NOTE

The pitch of a note depends on the tone that is being used, as shown in the Note Table on page A-1. Whenever this keyboard receives a note number that is outside its range for that tone, the same tone in the nearest available octave is substituted.

PROGRAM CHANGE

This is the tone selection message. PROGRAM CHANGE can contain tone data within the range of 0 to 127.

A PROGRAM CHANGE message is sent out through this keyboard's MIDI OUT terminal whenever you manually change its tone number. Receipt of a PROGRAM CHANGE message from an external machine changes the tone setting of this keyboard.

NOTE

This keyboard supports 128 tones in the range 0 to 127. However, Channel 10 is a percussion-only channel, and Channels 0, 8, 16, 24, 25, 32, 40, 48, and 62 correspond to the nine drum set sounds of this keyboard.

PITCH BEND

This message carries pitch bend information for smoothly sliding the pitch upwards or downwards during keyboard play. This keyboard does not send pitch bend data, but it can receive such data.

CONTROL CHANGE

This message adds effects such as vibrato and volume changes applied during keyboard play. CONTROL CHANGE data includes a control number (to identify the effect type) and a control value (to specify the on/off status and depth of the effect).

The following is a list of data that can be send or received using CONTROL CHANGE.

Effect	Control Number
★ Modulation	1
★ Volume	7
★ Pan	10
★ Expression	11
Hold1	64
Sostenuto	66
Soft Pedal	67
RPN*	100 / 101
Data Entry	6 / 38

★ indicates receive-only messages

* RPN stands for Registered Parameter Number, which is a special control change number used when combining multiple control changes. The parameter being controlled is selected using the control values of control numbers 100 and 101, and then settings are made using the control values of DATA ENTRY (control numbers 6 and 38).

This keyboard uses RPN to control this keyboard's pitch bend sense (pitch change width in accordance with bend data) from another external MIDI device, transpose (this keyboard's overall tuning adjusted in half-tone units), and tune (this keyboard's overall fine tuning).

NOTE

Sustain (control number 64), sostenuto (control number 66), and soft (control number 67) effects applied using the foot pedal are also applied.

ALL SOUND OFF

This message forces all sound being produced over the current channel to turn off, regardless of how the sound is being produced.

ALL NOTES OFF

This message turns off all note data sent from an external device and currently being sounded on the channel.

- Any notes being sustained using a sustain pedal or sostenuto pedal continue to sound until the next pedal off.

RESET ALL CONTROLLERS

This messages initializes pitch bend and all other control changes.

SYSTEM EXCLUSIVE*

This message is used to control system exclusives, which are tone fine adjustments that are unique to a particular machine. Originally, system exclusives were unique to a particular model, but now there are also universal system exclusives that are applicable to machines that are different models and even produced by different manufacturers.

The following are the system exclusive messages supported by this keyboard.

GM SYSTEM ON ([F0][7E][7F][09][01][F7])

GM SYSTEM ON is used by an external machine to turn on this keyboard's GM system. GM stands for General MIDI.

- GM SYSTEM ON takes more time to process than other messages, so when GM SYSTEM ON is stored in the sequencer it can take more than 100msec until the next message.

GM SYSTEM OFF ([F0][7E][7F][09][02][F7])

GM SYSTEM OFF is used by an external machine to turn off this keyboard's GM system.



Troubleshooting

Problem	Possible Cause	Action	See page
No keyboard Sound	<ol style="list-style-type: none"> 1. Power supply problem. 2. Power is not turned on. 3. Volume setting is too low. 4. The MODE switch is in the CASIO CHORD or FINGERED position. 5. LOCAL CONTROL is off. 6. MIDI data has changed the VOLUME and EXPRESSION settings to 0. 	<ol style="list-style-type: none"> 1. Correctly attach the AC adaptor, make sure that batteries poles (+/-) are facing correctly, and check to make sure that batteries are not dead. 2. Press the POWER button to turn on power. 3. Use the VOLUME slider to increase volume. 4. Normal play is not possible on the accompaniment keyboard while the MODE switch is set to CASIO CHORD or FINGERED. Change the MODE switch setting to NORMAL. 5. Turn on LOCAL CONTROL. 6. Adjust both parameters. 	<p>Page E-12</p> <p>Page E-14</p> <p>Page E-14</p> <p>Page E-17</p> <p>Page E-38</p> <p>Page E-40</p>
<p>Any of the following symptoms while using battery power.</p> <ul style="list-style-type: none"> • Dim power supply indicator • Instrument does not turn on. • Dim, difficult to read display • Abnormally low speaker/headphone volume • Distortion of sound output • Occasional interruption of sound when playing at high volumes • Sudden power failure when playing at high volumes • Dimming of the display when playing at high volume • Continued sound output even after you release a key • A totally different tone may sound • Abnormal rhythm pattern and demo tune play • Loss of power, sound distortion, or low volume when playing from a connected computer or MIDI device 	Low battery power	Replace the batteries with a set of new ones or use the AC adaptor.	Page E-12
Auto Accompaniment does not sound.	Accompaniment volume is set to 000.	Use the ACCOMP VOLUME button to increase the volume.	Page E-20
Sound output does not change when key pressure is varied.	Touch response is turned off.	Press the TOUCH RESPONSE button to turn it on.	Page E-34
On-screen keyboard guide keys stay on.	Keyboard is waiting for play of the correct note during Step 1 or Step 2 play.	<ol style="list-style-type: none"> 1. Press the lit key to continue with Step 1 or Step 2 play. 2. Press the START/STOP button to quit Step 1 or Step 2 play. 	<p>Page E-25</p> <p>Page E-25</p>
When playing with another MIDI instrument, keys or tunings do not match.	Transpose or tuning is set to a value other than 00.	Use the TRANSPOSE/TUNE/MIDI button to display the applicable setting screens and set both transpose and tuning to 00.	Page E-37
Cannot record Auto Accompaniment or rhythm.	Track other than Track 1 is selected as the recording track.	Use the track select buttons to select Track 1. (Track 2 is melody track.)	Page E-28
When playing General MIDI data with a computer, playback notes do not match those produced when lit keys on the on-screen keyboard guide are pressed.	Wrong SOUND RANGE SHIFT setting	Use the TRANSPOSE/TUNE/MIDI button to display the SOUND RANGE SHIFT screen and correct the setting.	Page E-39
Playing on the keyboard produces an unnatural sound when connected to a computer.	The computer's MIDI THRU function is turned on.	Turn off the MIDI THRU function on the computer or turn off LOCAL CONTROL on the keyboard.	Page E-38
Cannot record chord accompaniment data on a computer.	ACCOMP MIDI OUT is turned off.	Turn on ACCOMP MIDI OUT.	Page E-38

Specifications

Model:	CTK-571/CTK-573
Keyboard:	61 standard-size keys, 5 octaves (with touch response on/off)
Tones:	137 (128 General MIDI tones + 9 drum tones); with layer and split
Rhythm Instrument Tones:	61
Polyphony:	24 notes maximum (12 for certain tones)
Auto Accompaniment Rhythm Patterns: Tempo: Chords: Rhythm Controller: Accomp Volume: One Touch Presets:	100 Variable (216 steps, ♩ = 40 to 255) 3 fingering methods (CASIO CHORD, FINGERED, FULL RANGE CHORD) START/STOP, INTRO, NORMAL/NORMAL FILL-IN, VARIATION/VARIATION FILL-IN, SYNCHRO/ENDING 0 to 127 (128 steps) Recalls settings for tone, tempo, layer, split, and accompaniment volume in accordance with rhythm.
3-step Lesson: Playback:	3 lessons (Step 1, 2, 3) Repeat play of a single tune
Song Bank, Etude, Concert Piece Number of Tunes: Controllers:	100 (Song Bank: 50, Etude: 20, Concert Piece: 30) PLAY/PAUSE, STOP, FF, REW, LEFT/TRACK 1, RIGHT/TRACK 2
Musical Information Function:	Tone, Auto Accompaniment, Song Bank numbers and names; staff notation, tempo, metronome, measure and beat number, step lesson display, chord name, fingering, pedal operation, Keyboard, Piano mark
Metronome: Beat Specification:	On/Off 1 to 6
Memory Songs: Recording Tracks: Recording Method: Memory Capacity:	2 2 Real-time Approximately 5,200 notes (total for two songs)
MIDI:	16 multi-timbre receive, GM Level 1 standard
Other Functions Transpose: Tuning:	25 steps (-12 semitones to +12 semitones) 101 steps (A4 = approximately 440Hz ±50Cents)
Terminals MIDI Terminals: Assignable Jack: Headphone/Output Terminal: Output Impedance: Output Voltage:	IN, OUT Standard jack (sustain, sostenuto, soft, rhythm start/stop) Stereo standard jack 66Ω 3.0V (RMS) MAX
Power Jack:	9V DC
Power Supply: Batteries: Battery Life: AC Adaptor: Auto Power Off:	2-way 6 D-size batteries Approximately 6 hours continuous operation on manganese batteries AD-5 Turns power off approximately 6 minutes after last key operation. Enabled under batter power only, can be disabled manually.
Speaker Output:	2.0W + 2.0W
Power Consumption:	9V --- 7.7W
Dimensions:	96.1 x 37.5 x 14.3 cm (37 7/8 x 14 3/4 x 5 5/8 inch)
Weight:	Approximately 5.3 kg (11.7 lbs)(without batteries)

- Design and specifications are subject to change without notice.

Appendix/Apéndice

■ Note Table

■ Tabla de notas

(1)	(2)	(3)	(4)	(1)	(2)	(3)	(4)	(1)	(2)	(3)	(4)	(1)	(2)	(3)	(4)
000	24	A	A0 - C8	010	12	A	C4 - C6	020	24	A	C2 - C7	030	24	A	E2 - D6
001	24	A	A0 - C8	011	24	A	F3 - F6	021	12	A	F3 - F6	031	24	A	E2 - D6
002	12	A	A0 - C8	012	24	A	C3 - C6	022	24	A	C4 - C6	032	24	B	E1 - G3
003	12	A	A0 - C8	013	24	A	F4 - C7	023	12	A	F3 - F6	033	24	B	E1 - G3
004	24	A	E1 - G7	014	24	A	C4 - F5	024	24	A	E2 - C6	034	24	B	E1 - G3
005	24	A	E1 - G7	015	12	A	C4 - C6	025	24	A	E2 - C6	035	24	B	E1 - G3
006	24	A	F2 - F6	016	12	A	C2 - C7	026	24	A	E2 - D6	036	24	B	E1 - G3
007	24	A	C2 - C7	017	12	A	C2 - C7	027	24	A	E2 - D6	037	24	B	E1 - G3
008	24	A	C4 - C8	018	12	A	C2 - C7	028	24	A	E2 - D6	038	24	B	E1 - G3
009	24	A	C5 - C8	019	12	A	A0 - C8	029	24	A	E2 - D6	039	24	B	E1 - G3

(1)	(2)	(3)	(4)	(1)	(2)	(3)	(4)	(1)	(2)	(3)	(4)	(1)	(2)	(3)	(4)
040	24	A	G3 - C7	050	24	A	C2 - C7	060	12	A	F2 - F5	070	24	B	A [#] 1 - C5
041	24	A	C3 - C6	051	12	A	C2 - C7	061	24	A	C2 - C7	071	24	A	D3 - G6
042	24	A	C2 - C5	052	24	A	C3 - G5	062	12	A	C2 - C7	072	24	C	D5 - C8
043	24	B	E1 - G3	053	24	A	C3 - G5	063	12	A	C2 - C7	073	24	A	C4 - C7
044	24	A	E1 - C7	054	12	A	C3 - C6	064	24	A	F [#] 3 - D [#] 6	074	24	A	C4 - C7
045	24	A	E1 - C7	055	12	A	C3 - C5	065	24	A	C [#] 3 - G [#] 5	075	24	A	C4 - C7
046	24	A	B0 - G7	056	24	A	A [#] 3 - A [#] 6	066	24	A	F [#] 2 - D [#] 5	076	12	A	C4 - C7
047	24	B	C2 - A3	057	24	A	A [#] 1 - D [#] 5	067	24	B	C [#] 2 - G [#] 4	077	24	A	G3 - C6
048	24	A	E1 - C7	058	24	B	F1 - G3	068	24	A	A [#] 3 - G6	078	24	A	C4 - C7
049	24	A	E1 - C7	059	24	A	A [#] 3 - A [#] 5	069	24	A	E3 - A5	079	24	A	C4 - C6

(1)	(2)	(3)	(4)	(1)	(2)	(3)	(4)	(1)	(2)	(3)	(4)	(1)	(2)	(3)	(4)
080	12	A	A0 - C8	090	12	A	C2 - C7	100	12	A	C2 - C7	110	12	A	G3 - C7
081	12	A	A0 - C8	091	12	A	C2 - C7	101	12	A	C2 - C7	111	24	A	C3 - C5
082	12	A	C2 - C7	092	12	A	C2 - C7	102	12	A	C2 - C7	112	24	A	C5 - C6
083	12	A	C2 - C7	093	12	A	C2 - C7	103	12	A	C2 - C7	113	24	A	C4 - C5
084	12	A	C2 - C7	094	12	A	C2 - C7	104	24	A	C3 - F5	114	12	A	E3 - E5
085	12	A	C2 - C7	095	12	A	C2 - C7	105	24	A	C3 - C6	*115	24	D	C4 - C5
086	12	A	C2 - C7	096	12	A	C2 - C7	106	24	A	D3 - G5	*116	24	D	C4 - C5
087	12	A	A0 - C8	097	12	A	C2 - C7	107	24	A	G3 - C6	*117	24	D	C4 - C5
088	12	A	C2 - C7	098	12	A	C2 - C7	108	24	A	C3 - G5	*118	12	D	C4 - C5
089	24	A	C2 - C7	099	12	A	C2 - C7	109	12	A	C2 - F5	*119	24	D	C4 - C5

(1)	(2)	(3)	(4)
*120	24	D	C4 - C5
121	24	A	C4 - C5
*122	12	D	C4 - C5
*123	24	D	C4 - C5
*124	24	D	C4 - C5
*125	24	D	C4 - C5
*126	12	D	C4 - C5
*127	24	D	C4 - C5

■ NOTES ■

- (1) The meaning of each range type is described to the right.
- (2) The pitch of tones marked with an asterisk do not change, no matter which keyboard key is pressed.
- (3) Percussion sounds (tone numbers 128 to 136) have maximum polyphony of 12.
- (4) Turning on SOUND RANGE SHIFT (page E-39) causes range type B and C tones to shift by one octave.

■ NOTAS ■

- (1) El significado de cada tipo de gama se describe a la derecha.
- (2) La altura tonal de los sonidos marcados con un asterisco no cambian, sin tener en cuenta que tecla del teclado se presiona.
- (3) Los sonidos de percusión (números de sonido 128 a 136) tienen una polifonía máxima de 12.
- (4) Activando SOUND RANGE SHIFT (página S-39) ocasiona que los sonidos B y C de tipo de gama se desplacen en una octava.

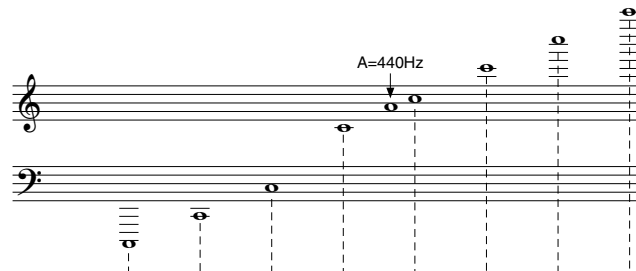

Range Type	C-1	C0	C1	C2	C3	C4	C5	C6	C7	G7	C8	C9	G9
A (Standard type) (Tipo estándar)													
B (Low pitch instruments) (Instrumentos de altura tonal baja)													
C ("072 PICCOLO" only) (Solamente "072 PICCOLO")													
D (Sound Effect) (Efecto de sonido)	No scale for tones. Sin escala para los sonidos.												

- aKeyboard range (SOUND RANGE SHIFT turned on)
Gama del teclado (SOUND RANGE SHIFT activados)
- bKeyboard range (SOUND RANGE SHIFT turned off)
Gama del teclado (SOUND RANGE SHIFT desactivados)
- cAvailable range (using transpose or MIDI receive)
Gama disponible (usando la transposición o recepción MIDI)
- dNotes in these ranges are produced by playing the notes in range c that are in the nearest octave as the result of transpose and MIDI data receive operations.
Las notas en estas gamas se producen ejecutando las notas en la gama c que se encuentre en la octava más cercana como resultado de las operaciones de transposición y recepción de datos MIDI.

■ Drum Assignment List (“←” Indicates the same sound as STANDARD SET)

■ Lista de sonidos de batería (“←” Indica el mismo sonido que STANDARD SET)

Key/Note number	Drumset 1 STANDARD SET	Drumset 2 ROOM SET	Drumset 3 POWER SET	Drumset 4 ELEC SET	Drumset 5 SYNTH SET	Drumset 6 JAZZ SET	Drumset 7 BRUSH SET	Drumset 8 ORCHESTRA SET	Drumset 9 VOICE SET
E1 28	HIGH Q	←	←	←	←	←	←	←	←
F1 29	SCRATCH PUSH	←	←	←	←	←	←	←	←
G1 31	SCRATCH PULL	←	←	←	←	←	←	←	←
A1 33	STICKS	←	←	←	←	←	←	←	←
B1 35	SQUARE CLICK	←	←	←	←	←	←	←	←
C2 36	METRONOME CLICK	←	←	←	←	←	←	←	←
D2 38	METRONOME BELL	←	←	←	←	←	←	←	←
E2 40	ACOUSTIC SNARE 1	←	←	←	←	←	←	←	←
F2 42	ACOUSTIC SNARE 2	←	←	←	←	←	←	←	←
G2 43	ACOUSTIC SNARE 2	←	←	←	←	←	←	←	←
A2 45	LOW FLOOR TOM	←	←	←	←	←	←	←	←
B2 47	LOW FLOOR TOM	←	←	←	←	←	←	←	←
C3 48	HIGH FLOOR TOM	←	←	←	←	←	←	←	←
D3 50	PEDAL HI-HAT	←	←	←	←	←	←	←	←
E3 52	LOW FLOOR TOM	←	←	←	←	←	←	←	←
F3 53	LOW FLOOR TOM	←	←	←	←	←	←	←	←
G3 55	LOW FLOOR TOM	←	←	←	←	←	←	←	←
A3 57	LOW FLOOR TOM	←	←	←	←	←	←	←	←
B3 59	LOW FLOOR TOM	←	←	←	←	←	←	←	←
C4 60	LOW FLOOR TOM	←	←	←	←	←	←	←	←
D4 62	LOW FLOOR TOM	←	←	←	←	←	←	←	←
E4 64	LOW FLOOR TOM	←	←	←	←	←	←	←	←
F4 65	LOW FLOOR TOM	←	←	←	←	←	←	←	←
G4 67	LOW FLOOR TOM	←	←	←	←	←	←	←	←
A4 69	LOW FLOOR TOM	←	←	←	←	←	←	←	←
B4 71	LOW FLOOR TOM	←	←	←	←	←	←	←	←
C5 72	LOW FLOOR TOM	←	←	←	←	←	←	←	←
D5 74	LOW FLOOR TOM	←	←	←	←	←	←	←	←
E5 76	LOW FLOOR TOM	←	←	←	←	←	←	←	←
F5 77	LOW FLOOR TOM	←	←	←	←	←	←	←	←
G5 79	LOW FLOOR TOM	←	←	←	←	←	←	←	←
A5 81	LOW FLOOR TOM	←	←	←	←	←	←	←	←
B5 83	LOW FLOOR TOM	←	←	←	←	←	←	←	←
C6 84	LOW FLOOR TOM	←	←	←	←	←	←	←	←
D6 86	LOW FLOOR TOM	←	←	←	←	←	←	←	←
E6 88	LOW FLOOR TOM	←	←	←	←	←	←	←	←

■ Fingered Chord Chart

■ Cuadros de acordes Fingered

Chord Type Root	M	m	7	m7	dim7	M7	m7 ⁻⁵	dim
C								
C [♯] /(D ^b)								
D								
(D [♯])/E ^b								
E								
F								
F [♯] /(G ^b)								
G								
(G [♯])/A ^b								
A								
(A [♯])/B ^b								
B								



Chord Type Root	aug	sus4	7sus4	m add9	mM7	7-5	add9
C							
C#/(Db)							
D							
(D#)/Eb							
E							
F							
F#/(Gb)							
G							
(G#)/Ab							
A							
(A#)/Bb							
B							

■ Tone List

■ Lista de sonidos

SYNTH-LEAD 080-087	094 HALO PAD	115 WOOD BLOCK
080 SQUARE WAVE	095 SWEEP PAD	116 TAIKO
081 SAWTOOTH WAVE	SYNTH-SFX 096-103	117 MELODIC TOM
082 CALLIOPE		118 SYNTH-DRUM
083 CHIFF LEAD	096 RAIN DROP	119 REVERSE CYMBAL
084 CHARANG	097 SOUNDTRACK	SOUND EFFECTS 120-127
085 VOICE LEAD	098 CRYSTAL	
086 FIFTH LEAD	099 ATMOSPHERE	120 GT FRET NOISE
087 BASS+LEAD	100 BRIGHTNESS	121 BREATH NOISE
SYNTH-PAD 088-095	101 GOBLINS	122 SEASHORE
	102 ECHOES	123 BIRD
088 NEW AGE	103 SF	124 TELEPHONE
089 WARM PAD	PERCUSSIVE 112-119	125 HELICOPTER
090 POLYSYNTH		112 TINKLE BELL
091 SPACE CHOIR	113 AGOGO	126 APPLAUSE
092 BOWED GLASS	114 STEEL DRUM	127 GUNSHOT
093 METALLIC PAD		

■ Rhythm List

■ Lista de ritmos

POPS		32 SLOW ROCK 2	65 VIENNESE WALTZ
00 POPS 1		33 SOFT ROCK 1	66 WALTZ
01 WORLD POP		34 SOFT ROCK 2	67 FRENCH WALTZ
02 SOUL BALLAD 1		35 SOFT ROCK 3	68 SERENADE
03 POP SHUFFLE		36 FOLKIE POP	69 TANGO
04 POP BALLAD		37 POP ROCK 1	
05 POPS 2		38 60'S SOUL	LATIN/VARIOUS
06 BALLAD		39 POP ROCK 2	70 BOSSA NOVA 1
07 FUSION SHUFFLE		40 ROCK 1	71 BOSSA NOVA 2
08 POPS 3		41 ROCK 2	72 SAMBA 1
09 SOUL BALLAD 2		42 POP ROCK 3	73 SAMBA 2
10 16 BEAT 1		43 RIFF ROCK	74 JAZZ SAMBA
11 16 BEAT 2		44 HEAVY METAL	75 MAMBO
12 16 BEAT 3		45 50'S ROCK	76 RHUMBA
13 8 BEAT 1		46 TWIST	77 CHA-CHA-CHA
14 8 BEAT 2		47 N'AWLINS R&R	78 MERENGUE
15 8 BEAT 3		48 CHICAGO BLUES	79 BOLERO
16 POPS 4		49 R & B	80 SALSA
17 DANCE POP			81 REGGAE
18 POP FUSION		JAZZ/FUSION	82 PUNTA
19 POP WALTZ		50 BIG BAND	83 CUMBIA
		51 JAZZ VOICES	84 PASODOBLE
DANCE/FUNK		52 SLOW SWING	85 RUMBA CATALANA
20 JUNGLE		53 SWING 1	86 SEVILLANA
21 RAVE		54 SWING 2	87 SKA
22 TECHNO		55 FOX TROT	88 TEX-MEX
23 GROOVE SOUL		56 MODERN JAZZ	89 FOLKLORE
24 DISCO		57 ACID JAZZ	90 COUNTRY
25 EURO BEAT		58 LATIN FUSION	91 BLUEGRASS
26 RAP		59 JAZZ WALTZ	92 TOWNSHIP
27 TRANCE			93 FAST GOSPEL
28 FUNK		EUROPEAN	94 SLOW GOSPEL
29 VERY FUNKY		60 POLKA 1	95 RAI
		61 POLKA 2	96 ADANI
ROCK		62 MARCH 1	97 BALADI
30 ROCK WALTZ		63 MARCH 2	98 ENKA
31 SLOW ROCK 1		64 SLOW WALTZ	99 STR QUARTET

Model CTK-571/CTK-573 MIDI Implementation Chart

Version: 1.0

Function ...	Transmitted	Recognized	Remarks
Basic Channel Default Changed	1-16*1 1-16	1-16 1-16	*1 Hold in memory as long as the power is supplied
Mode Default Messages Altered	Mode 3 X *****	Mode 3 X *****	
Note Number: True voice	36 - 96 *****	0-127 12 - 108*2	*2 See Note Table on page A-1.
Velocity Note ON Note OFF	0 9nH v = 1-127 X 9nH v = 0	0 9nH v = 1-127 X 9nH v = 0, 8nH v = XX	XX = no relation
After Touch Key's Ch's	X X	X O*3	
Pitch Bender	X	O	
Control Change 1 6,38 7 10 11 64 66 67	X O*4 X X X O*5 O*5 O*5	O*3 O*4 O O O O O O	Modulation Data entry Volume Pan Expression Hold1 Sostenuto Soft pedal
100, 101 120 121	O*4 X X	O*4 O O	RPN LSB, MSB All sound off Reset all controller

<p>67</p> <p><input type="radio"/> *5</p>	<p><input type="radio"/></p>	<p><input type="radio"/></p>	<p>Soft pedal</p>
<p>100, 101 120 121</p>	<p><input type="radio"/> *4 X X</p>	<p><input type="radio"/> *4 O O</p>	<p>RPN LSB, MSB All sound off Reset all controller</p>
<p>Program Change: True #</p>	<p><input type="radio"/> 0-127 *****</p>	<p><input type="radio"/> 0-127 *****</p>	
<p>System Exclusive</p>	<p><input type="radio"/> *6</p>	<p><input type="radio"/> *6</p>	
<p>System : Song Pos Common : Song Sel : Tune</p>	<p>X X X</p>	<p>X X X</p>	
<p>System : Clock Real Time : Commands</p>	<p>O O</p>	<p>X X</p>	
<p>Aux : Local ON/OFF : All notes OFF Messages : Active Sense : Reset</p>	<p>X X X X</p>	<p>X O O X</p>	
<p>Remarks</p>	<p>*3 Modulation and after touch for each channel are the same effect. *4 FINE TUNE, COARSE TUNE send/receive, and PITCH BEND SENSE, RPN Null receive *5 In accordance with assignable jack setting *6 GM on/off GM ON : [F0] [7E] [7F] [09] [01] [F7] GM OFF : [F0] [7E] [7F] [09] [02] [F7]</p>		

Mode 1 : OMNI ON, POLY
Mode 3 : OMNI OFF, POLY

Mode 2 : OMNI ON, MONO
Mode 4 : OMNI OFF, MONO

O : Yes
X : No

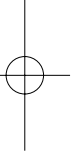



This recycle mark indicates that the packaging conforms to the environmental protection legislation in Germany.
Esta marca de reciclaje indica que el empaquetado se ajusta a la legislación de protección ambiental en Alemania.

CASIO®

CASIO COMPUTER CO.,LTD.
6-2, Hon-machi 1-chome
Shibuya-ku, Tokyo 151-8543, Japan

MA0103-B (英) (西) Printed in Malaysia
CTK571/573-ES-1